

A. Detachable body components

Sedan

Engine hood

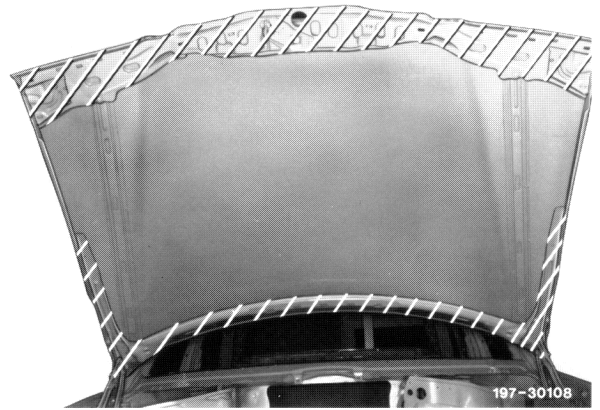

Front fender:
Range behind bulkhead,
cutout for turnsignal lamp



Driver's door in lower range,
holding rail for sealing frame

Note: Glue in insulation prior to waxing.

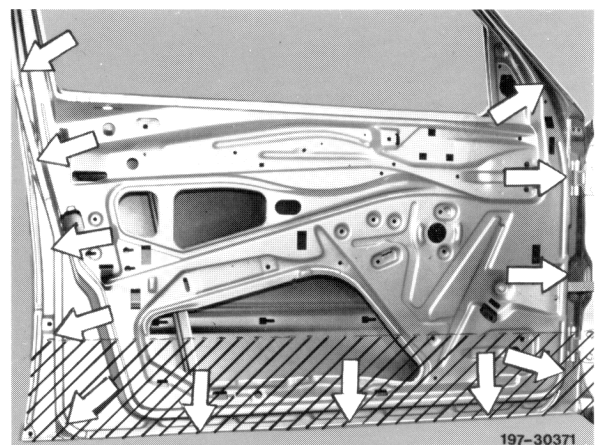

Rear door in lower range,
holding rail for sealing frame

Note: Glue in insulation prior to waxing.

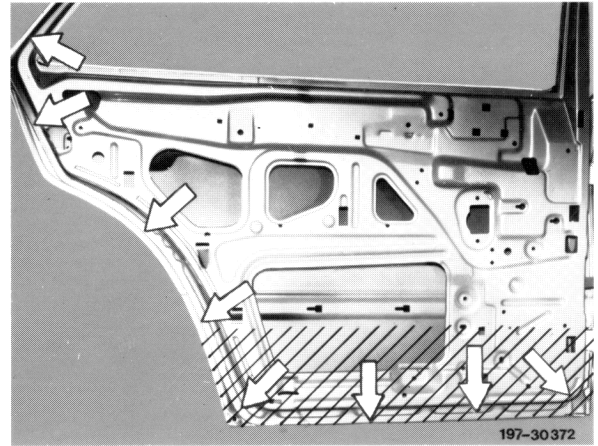

Trunk lid below and laterally

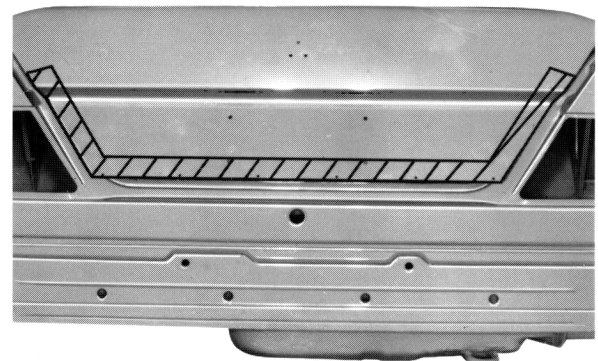

T-sedan

(ranges deviating from sedan)

Tailgate all-around

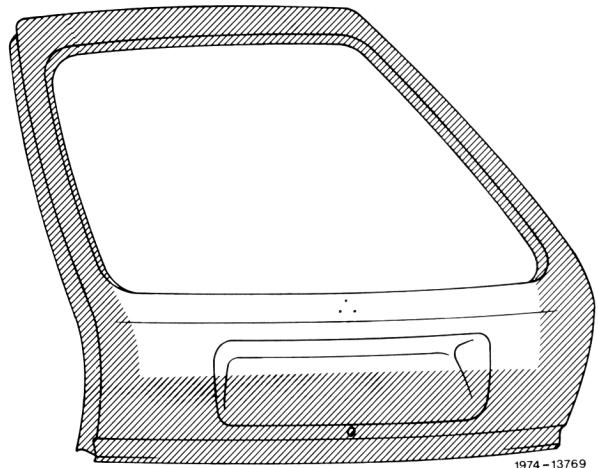

B. Welded-in parts

Sedan

Side member front, cross member front

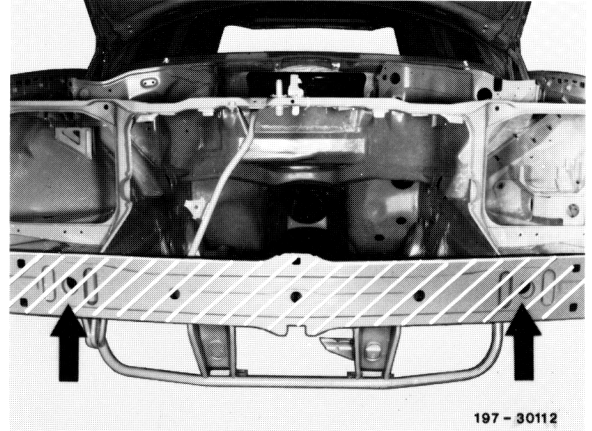

Side member front, damper mandrel, engine carrier, fork carrier inside, axle mount

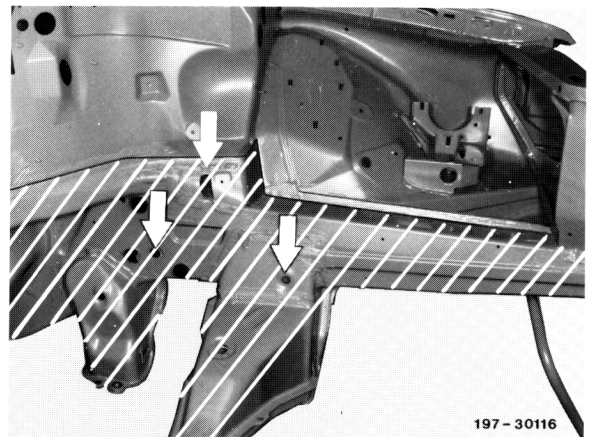

Engine carrier

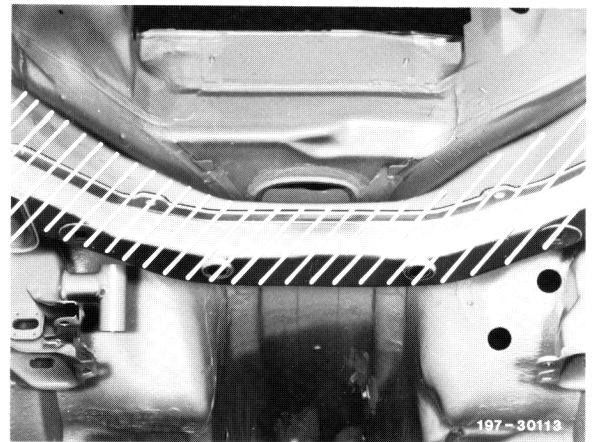

Fork carrier inside, front wall, left and right

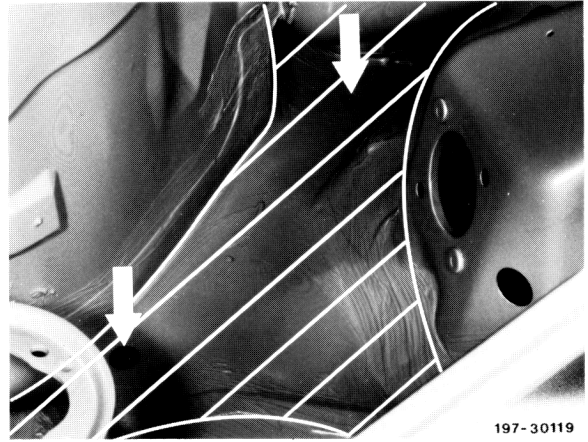

Reinforcement engine hood hinge left and right

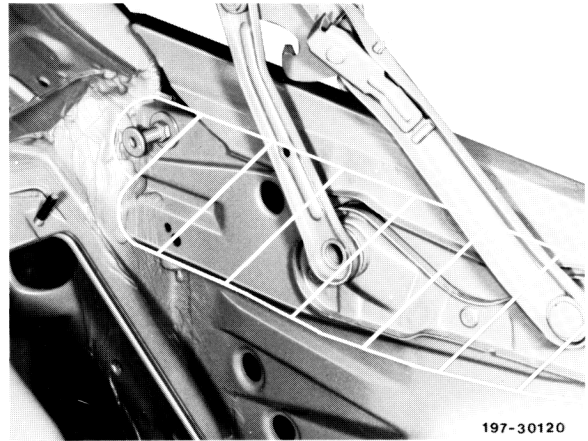

Engine carrier, axle mounts, side member, outer fork carrier, outer side member, left and right

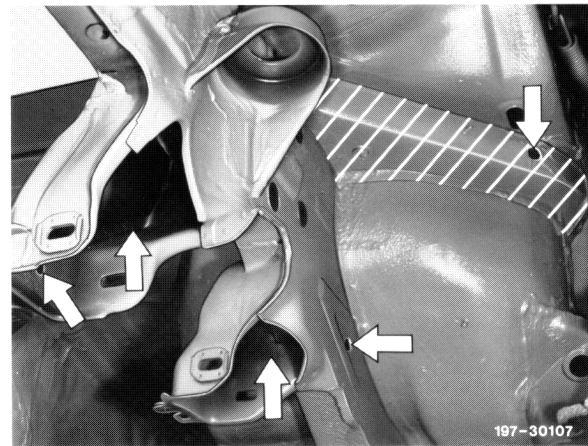

Console for intermediate steering arm, axle mount, holder for steering shock absorber

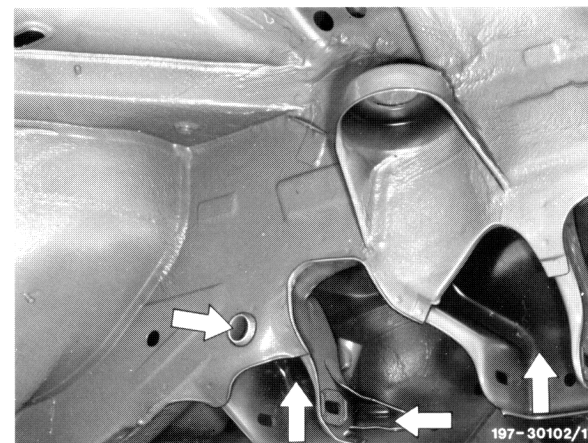

Cross member under windshield, front wall pillar in lower range, outer side member, left and right

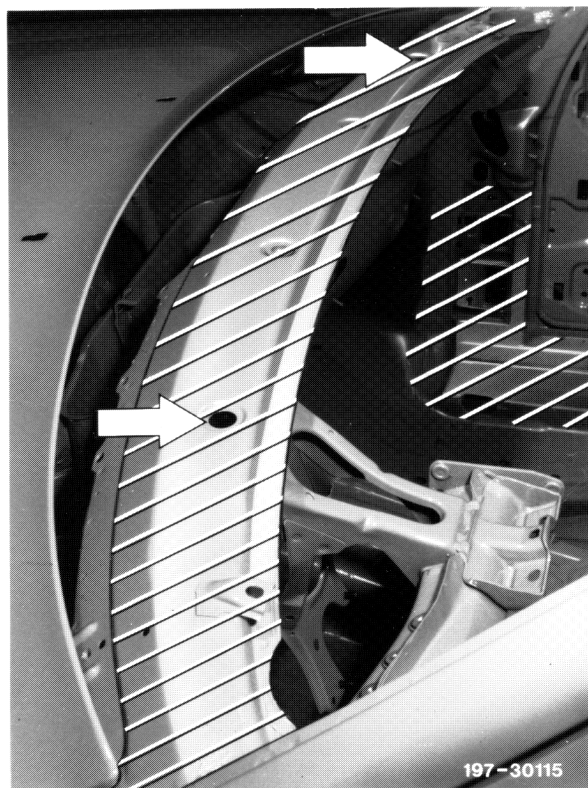

Inner connecting member, floor-tunnel carrier, left and right

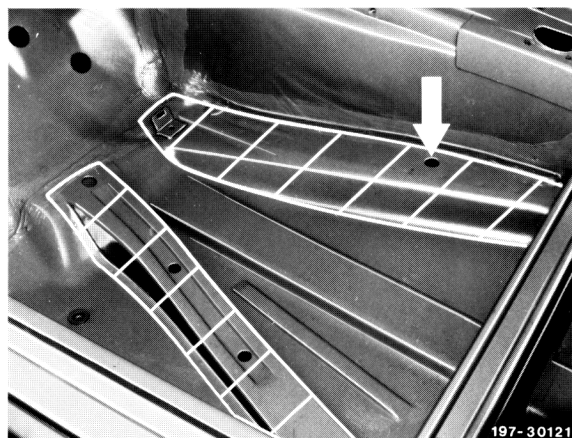

Outer side member, lower center pillar, rear side member, wheelhouse, rear fender, left and right

Side member rear: a cavity from above, a cavity laterally from inside

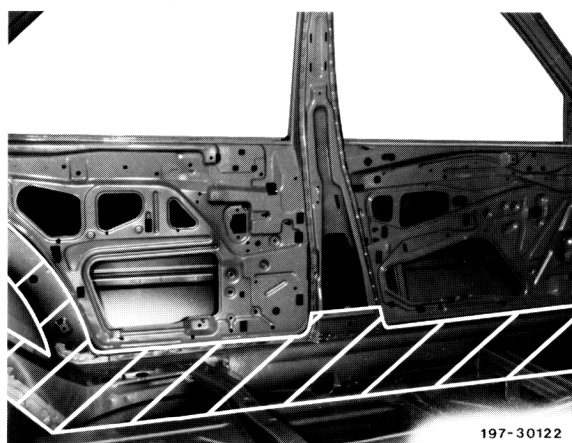

Wheelhouse, rear fender, left and right



197-30123

Vehicle jack tube, mount for plug (lifting platform) on floor laterally front and rear

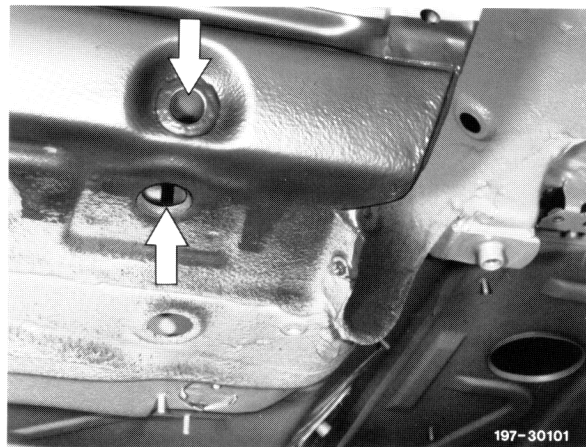

197-30101

Side member, cross member above rear axle, console for axle mount, left and right

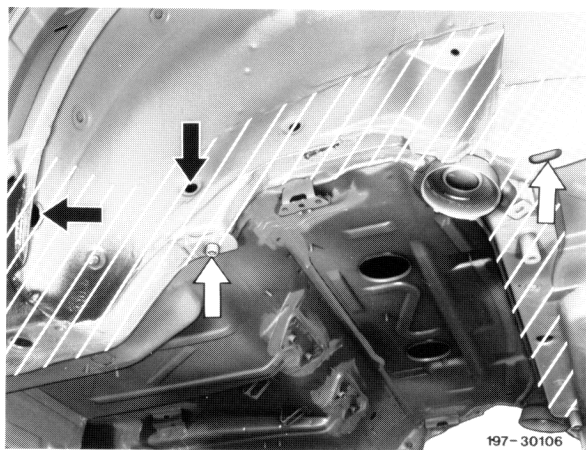

197-30106

Cross member above rear axle



197-30117

Cross member, rear

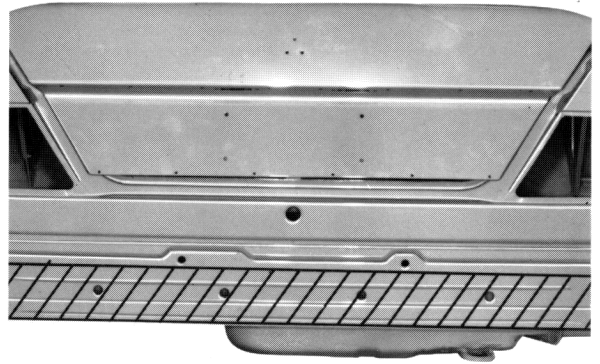

197-30118/1

Cross member rear from below, preserve entire width of bumper prior to assembly, holder for rear end muffler

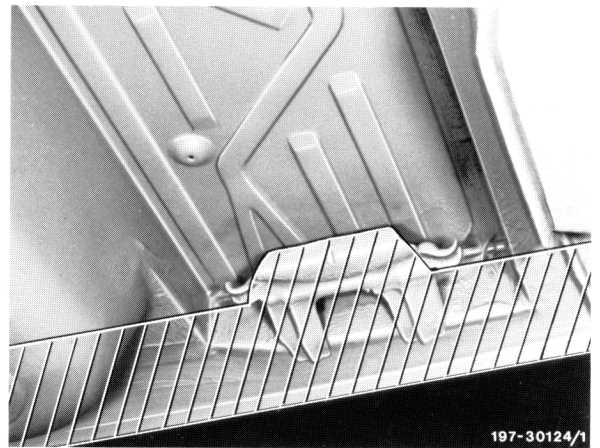

197-30124/1

T-sedan

(ranges deviating from sedan)

Cross member above rear axle, cross member rear from above and from the rear (2 cavities), rear fender rear and range at tail lamp unit, hinge range for tailgate, left and right

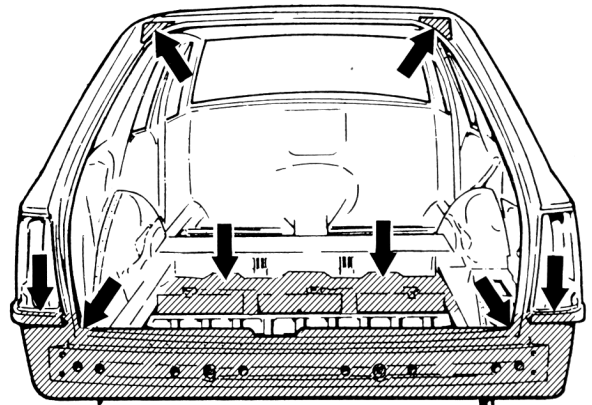

1974-13766

Preserve cross member rear from below, entire width prior to assembly of bumper, towing eye, holder for end muffler left and right

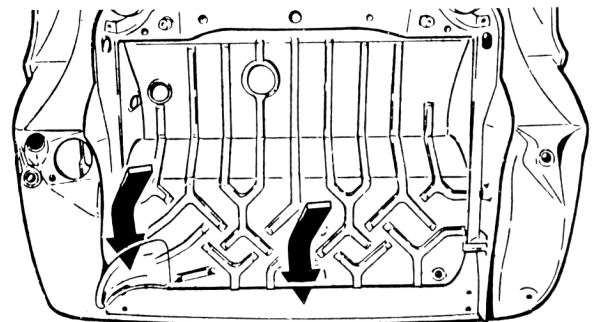

1974-13761

Convertible
(areas deviating from sedan)

Reinforcement plate on front wall in wheelhouse
on left and right.

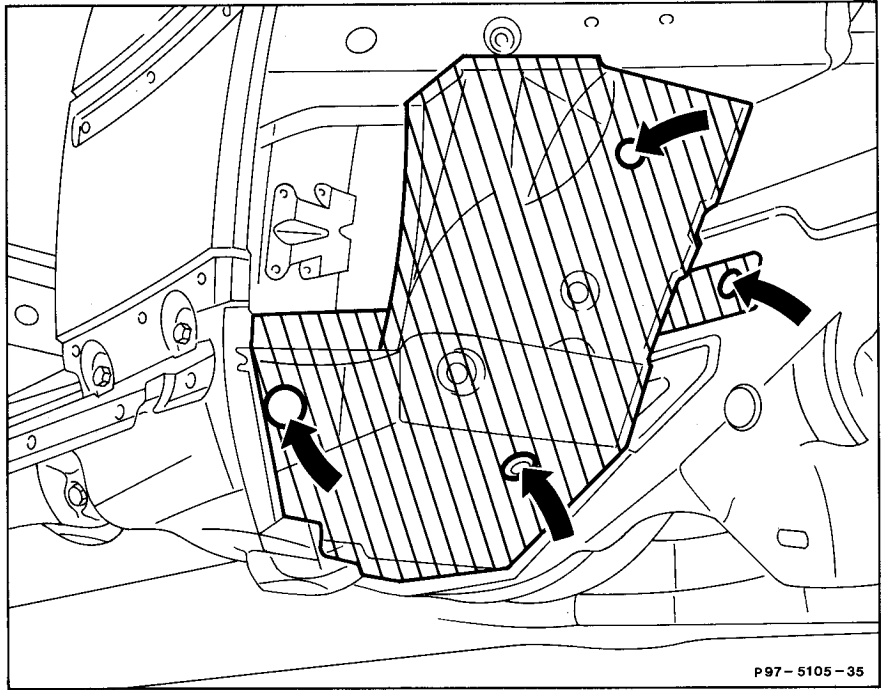

B-pillar at top and reinforcement plate in rear
side wall on left and right.

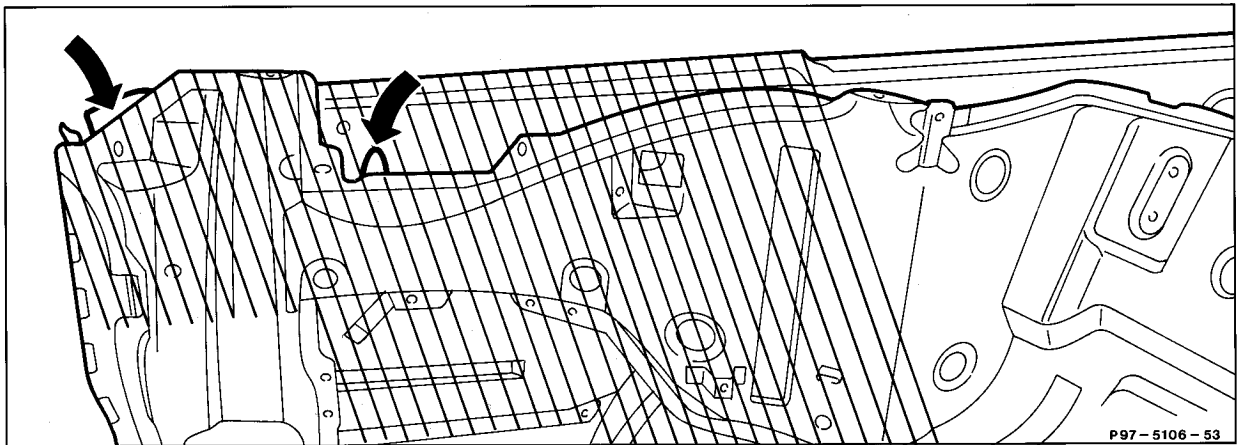

Reinforcement plate in rear side wall in area of soft top compartment – wheelhouse on left and right.

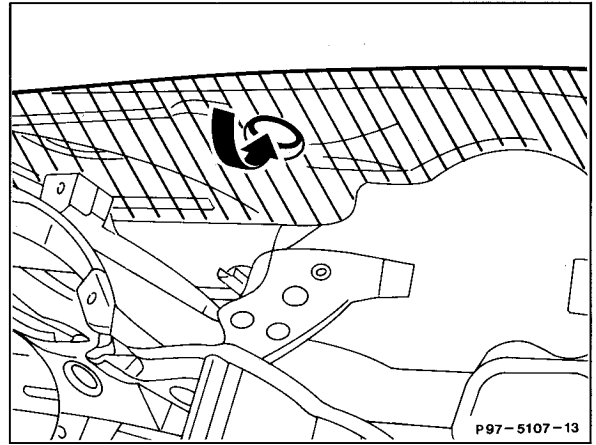

Apply wax to console on spare wheel recess from inside.

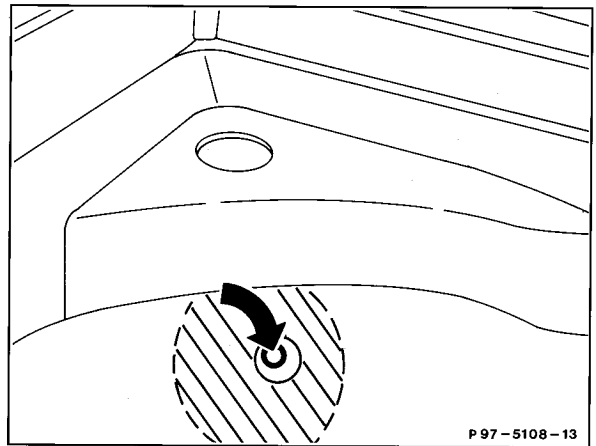

Bracket for diagonal braces

Reinforcement plate for rear frame side member above rear axle on left and right.

