



N2 GF40.10-P-0991A	Survey of tires/disk wheels/recommended tire make/snow chains	10.6.97
-----------------------	---	---------

MODEL all

	Spare wheel with inflatable spare tire	Model 170	AH40.10-P-0002-01A H18
	Notes on spare wheel	Models 208, 220	AH40.10-P-0004-01A J18
	TIREFIT tire sealant	Models 168, 170	AH40.10-P-0001-01A E18
	General notes on disc wheels/tire conversions	Models 124, 129, 140, 163, 168, 170, 201, 202, 208, 210, 220	AH40.10-P-1050-01A F18
	General notes on chassis modifications	Models 124, 129, 140, 163, 168, 170, 201, 202, 208, 210, 220	AH40.10-P-1050-02A G18
	General notes on Continental Tyre System (CTS)	Model 140 with Conti-Tyre-System (CTS) tires	AH40.10-P-1060-01A K18
	Notes on tires/disc wheels	Models 124, 129, 140, 163, 168, 170, 201, 202, 208, 210, 220	AH40.10-P-9411-01A B18
	Snow chains		GF40.10-P-1070A M14
	Survey of winter tires/disc wheels/ recommended tire makes/snow chains	Model 124 Model 124 with code 990 AMG vehicles Model 129 Model 129 with code 990 AMG vehicles Model 140	GF40.10-P-1050-01A A3 GF40.10-P-1050-01AM N3 GF40.10-P-1050-01B O3 GF40.10-P-1050-01BM P3 GF40.10-P-1050-01C A4

		Model 163	GF40.10-P-1050-01GH	B4
		Model 168	GF40.10-P-1050-01GC	C4
		Model 170	GF40.10-P-1050-01K	D4
		Model 201	GF40.10-P-1050-01D	E4
		Model 202	GF40.10-P-1050-01E	F4
		Model 202 with code 990 AMG vehicles	GF40.10-P-1050-01EM	K4
		Model 208	GF40.10-P-1050-01O	M4
		Model 210	GF40.10-P-1050-01F	O4
		Model 210 with code 990 AMG vehicles	GF40.10-P-1050-01FM	J5
		Model 220	GF40.10-P-1050-01P	K5
	Survey of summer tires/disc wheels/ recommended tire makes	Model 124	GF40.10-P-1050-02A	L5
		Model 124 with code 990 AMG vehicles	GF40.10-P-1050-02AM	K6
		Model 129	GF40.10-P-1050-02B	N6
		Model 129 with code 990 AMG vehicles	GF40.10-P-1050-02BM	O6
		Model 140	GF40.10-P-1050-02C	A7
		Model 140 with code 990 AMG vehicles	GF40.10-P-1050-02CM	D7
		Model 163	GF40.10-P-1050-02GH	E7
		Model 168	GF40.10-P-1050-02GC	F7



		Model 168 with code 990 AMG vehicles	GF40.10-P-1050-02GCM	
		Model 170	GF40.10-P-1050-02K	H7
		Model 170 with code 990 AMG vehicles	GF40.10-P-1050-02KM	K7
		Model 201	GF40.10-P-1050-02D	L7
		Model 201 with code 990 AMG vehicles	GF40.10-P-1050-02DM	N7
		Model 202	GF40.10-P-1050-02E	O7
		Model 202 with code 990 AMG vehicles	GF40.10-P-1050-02EM	K8
		Model 208	GF40.10-P-1050-02O	M8
		Model 208 with code 990 AMG vehicles	GF40.10-P-1050-02OM	O8
		Model 210	GF40.10-P-1050-02F	P8
		Model 210 with code 990 AMG vehicles	GF40.10-P-1050-02FM	D10
		Model 220	GF40.10-P-1050-02P	E10
		Model 220 with code 990 AMG vehicles	GF40.10-P-1050-02PM	J10
AN	Retrofit conversion to Mercedes-Benz 8-hole 7J x 16 H2 ET46 light-alloy disc wheel with 215/55 R 16 tire	Model 124	AN40.10-P-1050-01A	K10
AN	Retrofit conversion to Mercedes-Benz 5-hole 8 1/2J x 18 H2 ET47 light-alloy disc wheel with 255/45 R18 tire	Model 140 (except and special protection vehicles)	AN40.10-P-1050-02A	N10

A3	GF40.10-P-1050-01A	Survey of winter tires/disk wheels/recommended tire makes/snow chains	Model 124except	 GF
-----------	--------------------	---	-----------------	---

Model	Tire designation	Disc wheel designation	Sheet-steel	Light-alloy	Recommended tire makes	Snow chain option
124 except (124.003/004/ 007/008/020/ 027/029/034/ 036/104/105/ 106/107/120/ 127/129)	195/65 R 15 91 Q M&S	6.5Jx15 H2 ET 44 6.5Jx15 H2 ET 48 6.5Jx15 H2 ET 49	X	X X X	CONTINENTAL Vinking Stop 4000 ⁴⁾ MICHELIN Ivalo ⁴⁾	yes
124 Sports suspension up to E30	205/60 R 15 91 H M&S	7Jx15 H2 ET 41 7Jx15 H2 ET 42	X	X	CONTINENTAL Winter Contact TS 770 DUNLOP SP Winter Sport M2 PIRELLI Winter 210 Asimmetrico SEMPERIT Direction Grip MICHELIN Pilot Alpin	yes
124 Sports suspension E32	205/60 R 15 91 H M&S	7Jx15 H2 ET 41 7Jx15 H2 ET 42	X	X	CONTINENTAL Winter Contact TS 770 DUNLOP SP Winter Sport M2 PIRELLI Winter 210 Asimmetrico SEMPERIT Direction Grip MICHELIN Pilot Alpin	yes
124.003 As of vehicle ident. end no. 1F-163 558	195/65 R 15 95 T M&S Reinforced	6.5Jx15 H2 ET 48	X	X	CONTINENTAL Winter Contact TS 770	yes
As of vehicle ident. end no. 1F-163 558	205/65 R 15 99 S M&S Reinforced	6.5Jx15 H2 ET 48	X	X	CONTINENTAL Winter Contact TS 750	yes

2) An entry in the vehicle documents is required in the Federal Republic of Germany when 195/65 R 15 Q or T M + S are used on the 6.5Jx15 H2 ET 44/48/49 disc wheel. Abroad, observe the legislation of the particular country.

4) Only for Scandinavia and countries where spiked tires are permitted. Tire fitted with plastic-coated studs.

5) For retrofitting winter tires only.

Model	Tire designation	Disc wheel designation	Sheet-steel	Light-alloy	Recommended tire makes	Snow chain option
Up to of vehicle ident. end no. 1F-163 557	195/65 R 15 91 T M&S	6.5Jx15 H2 ET 44 6.5Jx15 H2 ET 48 6.5Jx15 H2 ET 49	X	X X X	CONTINENTAL Winter Contact TS 770 DUNLOP SP Winter Sport M2 MICHELIN XM + S 130 PIRELLI Winter 190 Asimmetrico SEMPERIT Top Grip SLG	yes
Up to of vehicle ident. end no. 1F-163 557	195/65 R 15 91 H M&S	6.5Jx15 H2 ET 44 6.5Jx15 H2 ET 48 6.5Jx15 H2 ET 49	X	X X X	CONTINENTAL Winter Contact TS 790	yes
124.004/007 As of vehicle ident. end no. 1F-161 237	195/65 R 15 95 T M&S Reinforced	6.5Jx15 H2 ET 48	X	X	CONTINENTAL Winter Contact TS 770	yes
As of vehicle ident. end no. 1F-161 237	205/65 R 15 99 S M&S Reinforced	6.5Jx15 H2 ET 48	X	X	CONTINENTAL Winter Contact TS 750	yes
Up to of vehicle ident. end no. 1F-161 236	195/65 R 15 91 T M&S	6.5Jx15 H2 ET 44 6.5Jx15 H2 ET 48 6.5Jx15 H2 ET 49	X	X X X	CONTINENTAL Winter Contact TS 770 DUNLOP SP Winter Sport M2 MICHELIN XM + S 130 PIRELLI Winter 190 Asimmetrico SEMPERIT Top Grip SLG	yes
Up to of vehicle ident. end no. 1F-161 236	195/65 R 15 91 H M&S	6.5Jx15 H2 ET 44 6.5Jx15 H2 ET 48 6.5Jx15 H2 ET 49	X	X X X	CONTINENTAL Winter Contact TS 790	yes
124.008	195/65 R 15 95 T M&S Reinforced	6.5Jx15 H2 ET 48 6.5Jx15 H2 ET 49		X X	CONTINENTAL Winter Contact TS 770	yes

2) An entry in the vehicle documents is required in the Federal Republic of Germany when 195/65 R 15 Q or T M + S are used on the 6.5Jx15 H2 ET 44/48/49 disc wheel. Abroad, observe the legislation of the particular country.

4) Only for Scandinavia and countries where spiked tires are permitted. Tire fitted with plastic-coated studs.

5) For retrofitting winter tires only.

Model	Tire designation	Disc wheel designation	Sheet-steel	Light-alloy	Recommended tire makes	Snow chain option
124.019	195/65 R 15 91 T M&S	6.5Jx15 H2 ET 44 6.5Jx15 H2 ET 48 6.5Jx15 H2 ET 49	X	X X X	CONTINENTAL Winter Contact TS 770 DUNLOP SP Winter Sport M2 MICHELIN XM + S 130 PIRELLI Winter 190 Asimmetrico SEMPERIT Top Grip SLG	yes
	195/65 R 15 91 H M&S	6.5Jx15 H2 ET 44 6.5Jx15 H2 ET 48 6.5Jx15 H2 ET 49	X	X X X	CONTINENTAL Winter Contact TS 790	yes
124.020 ²⁾	185/65 R 15 88 T M&S	6Jx15 H2 ET 49	X	X	CONTINENTAL Winter Contact TS 770 DUNLOP SP Winter Sport M2 MICHELIN XM + S 130 PIRELLI Winter 190 Asimmetrico	yes
with suspension for increased payload	195/65 R 15 91 T M&S	6.5Jx15 H2 ET 44 6.5Jx15 H2 ET 48 6.5Jx15 H2 ET 49	X	X X X	CONTINENTAL Winter Contact TS 770 DUNLOP SP Winter Sport M2 MICHELIN XM + S 130 PIRELLI Winter 190 Asimmetrico SEMPERIT Top Grip SLG	yes
	195/65 R 15 91 H M&S	6.5Jx15 H2 ET 44 6.5Jx15 H2 ET 48 6.5Jx15 H2 ET 49	X	X X X	CONTINENTAL Winter Contact TS 790	yes
124.021/022 023/026	195/65 R 15 91 T M&S	6.5Jx15 H2 ET 44 6.5Jx15 H2 ET 48 6.5Jx15 H2 ET 49	X	X X X	CONTINENTAL Winter Contact TS 770 DUNLOP SP Winter Sport M2 MICHELIN XM + S 130 PIRELLI Winter 190 Asimmetrico SEMPERIT Top Grip SLG	yes
	195/65 R 15 91 H M&S	6.5Jx15 H2 ET 44 6.5Jx15 H2 ET 48 6.5Jx15 H2 ET 49	X	X X X	CONTINENTAL Winter Contact TS 790	yes

2) An entry in the vehicle documents is required in the Federal Republic of Germany when 195/65 R 15 Q or T M + S are used on the 6.5Jx15 H2 ET 44/48/49 disc wheel. Abroad, observe the legislation of the particular country.

4) Only for Scandinavia and countries where spiked tires are permitted. Tire fitted with plastic-coated studs.

5) For retrofitting winter tires only.

Model	Tire designation	Disc wheel designation	Sheet-steel	Light-alloy	Recommended tire makes	Snow chain option
124.027	205/65 R 15 94 H M&S	6.5Jx15 H2 ET 48 6.5Jx15 H2 ET 49	X	X X	CONTINENTAL Winter Contact TS 770 DUNLOP SP Winter Sport M2 MICHELIN XM + S 330 SEMPERIT Top Grip SLG MICHELIN Pilot Alpin	yes
	205/65 R 15 94 Q M&S	6.5Jx15 H2 ET 48 6.5Jx15 H2 ET 49	X	X X	CONTINENTAL Viking Stop 4000 ⁴⁾	yes
124.028	195/65 R 15 91 T M&S	6.5Jx15 H2 ET 44 6.5Jx15 H2 ET 48 6.5Jx15 H2 ET 49	X	X X X	CONTINENTAL Winter Contact TS 770 DUNLOP SP Winter Sport M2 MICHELIN XM + S 130 PIRELLI Winter 190 Asimmetrico SEMPERIT Top Grip SLG	yes
	195/65 R 15 91 H M&S	6.5Jx15 H2 ET 44 6.5Jx15 H2 ET 48 6.5Jx15 H2 ET 49	X	X X X	CONTINENTAL Winter Contact TS 790	yes
124.029	205/65 R 15 94 H M&S	6.5Jx15 H2 ET 48 6.5Jx15 H2 ET 49		X X	CONTINENTAL Winter Contact TS 770 DUNLOP SP Winter Sport M2 MICHELIN XM + S 330 SEMPERIT Top Grip SLG MICHELIN Pilot Alpin	yes
	205/65 R 15 94 Q M&S	6.5Jx15 H2 ET 48 6.5Jx15 H2 ET 49	X	X X	CONTINENTAL Viking Stop 4000 ⁴⁾	yes
124.030	195/65 R 15 91 T M&S	6.5Jx15 H2 ET 44 6.5Jx15 H2 ET 48 6.5Jx15 H2 ET 49	X	X X X	CONTINENTAL Winter Contact TS 770 DUNLOP SP Winter Sport M2 MICHELIN XM + S 130 PIRELLI Winter 190 Asimmetrico SEMPERIT Top Grip SLG	yes

2) An entry in the vehicle documents is required in the Federal Republic of Germany when 195/65 R 15 Q or T M + S are used on the 6.5Jx15 H2 ET 44/48/49 disc wheel. Abroad, observe the legislation of the particular country.

4) Only for Scandinavia and countries where spiked tires are permitted. Tire fitted with plastic-coated studs.

5) For retrofitting winter tires only.



Model	Tire designation	Disc wheel designation	Sheet-steel	Light-alloy	Recommended tire makes	Snow chain option
	195/65 R 15 91 H M&S	6.5Jx15 H2 ET 44 6.5Jx15 H2 ET 48 6.5Jx15 H2 ET 49	X	X X X	CONTINENTAL Winter Contact TS 790	yes
124.031/032	195/65 R 15 91 T M&S	6.5Jx15 H2 ET 44 6.5Jx15 H2 ET 48 6.5Jx15 H2 ET 49		X X X	CONTINENTAL Winter Contact TS 770 DUNLOP SP Winter Sport M2 MICHELIN XM + S 130 PIRELLI Winter 190 Asimmetrico SEMPERIT Top Grip SLG	yes
	195/65 R 15 91 H M&S	6.5Jx15 H2 ET 44 6.5Jx15 H2 ET 48 6.5Jx15 H2 ET 49	X	X X X	CONTINENTAL Winter Contact TS 790	yes
124.034 Up to of vehicle ident. end no. 1B- 938 868	195/65 R 15 91 T M&S	6.5Jx15 H2 ET 44 6.5Jx15 H2 ET 48 6.5Jx15 H2 ET 49		X X X	CONTINENTAL Winter Contact TS 770 DUNLOP SP Winter Sport M2 MICHELIN XM + S 130 PIRELLI Winter 190 Asimmetrico SEMPERIT Top Grip SLG	yes
	195/65 R 15 91 H M&S	6.5Jx15 H2 ET 44 6.5Jx15 H2 ET 48 6.5Jx15 H2 ET 49	X	X X X	CONTINENTAL Winter Contact TS 790	yes
	215/55 R 16 91 H M&S	7Jx16 H2 ET 46		X	PIRELLI Winter 210 Performance PIRELLI Winter 210 Asimmetrico	yes
124.036	225/55 R16 95 H M&S	8Jx16 H2 ET 34 8Jx16 H2 ET 35 ⁵⁾	X	X	CONTINENTAL Winter Sport Contact TS 770 DUNLOP SP Winter Sport M2	yes
124.04/050	195/65 R 15 91 T M&S	6.5Jx15 H2 ET 44 6.5Jx15 H2 ET 48 6.5Jx15 H2 ET 49	X	X X X	CONTINENTAL Winter Contact TS 770 DUNLOP SP Winter Sport M2 MICHELIN XM + S 130 PIRELLI Winter 190 Asimmetrico SEMPERIT Top Grip SLG	yes

2) An entry in the vehicle documents is required in the Federal Republic of Germany when 195/65 R 15 Q or T M + S are used on the 6.5Jx15 H2 ET 44/48/49 disc wheel. Abroad, observe the legislation of the particular country.

4) Only for Scandinavia and countries where spiked tires are permitted. Tire fitted with plastic-coated studs.

5) For retrofitting winter tires only.

Model	Tire designation	Disc wheel designation	Sheet-steel	Light-alloy	Recommended tire makes	Snow chain option
	195/65 R 15 91 H M&S	6.5Jx15 H2 ET 44 6.5Jx15 H2 ET 48 6.5Jx15 H2 ET 49	X	X X X	CONTINENTAL Winter Contact TS 790	yes
124.051/052	195/65 R 15 91 T M&S	6.5Jx15 H2 ET 44 6.5Jx15 H2 ET 48 6.5Jx15 H2 ET 49		X X X	CONTINENTAL Winter Contact TS 770 DUNLOP SP Winter Sport M2 MICHELIN XM + S 130 PIRELLI Winter 190 Asimmetrico SEMPERIT Top Grip SLG	yes
	195/65 R 15 91 H M&S	6.5Jx15 H2 ET 44 6.5Jx15 H2 ET 48 6.5Jx15 H2 ET 49	X	X X X	CONTINENTAL Winter Contact TS 790	yes
124.060	195/65 R 15 91 T M&S	6.5Jx15 H2 ET 44 6.5Jx15 H2 ET 48 6.5Jx15 H2 ET 49	X	X X X	CONTINENTAL Winter Contact TS 770 DUNLOP SP Winter Sport M2 MICHELIN XM + S 130 PIRELLI Winter 190 Asimmetrico SEMPERIT Top Grip SLG	yes
E 20	195/65 R 15 91 T M&S	6.5Jx15 H2 ET 44 6.5Jx15 H2 ET 48 6.5Jx15 H2 ET 49		X X X	CONTINENTAL Winter Contact TS 770 DUNLOP SP Winter Sport M2 MICHELIN XM + S 130 PIRELLI Winter 190 Asimmetrico	yes
	195/65 R 15 91 H M&S	6.5Jx15 H2 ET 44 6.5Jx15 H2 ET 48 6.5Jx15 H2 ET 49	X	X X X	CONTINENTAL Winter Contact TS 790	yes
E 20	205/60 R 15 91 H M&S	7Jx15 H2 ET 41		X	CONTINENTAL Winter Contact TS 770 DUNLOP SP Winter Sport M2 PIRELLI Winter 210 Asimmetrico MICHELIN Pilot Alpin	yes

2) An entry in the vehicle documents is required in the Federal Republic of Germany when 195/65 R 15 Q or T M + S are used on the 6.5Jx15 H2 ET 44/48/49 disc wheel. Abroad, observe the legislation of the particular country.

4) Only for Scandinavia and countries where spiked tires are permitted. Tire fitted with plastic-coated studs.

5) For retrofitting winter tires only.

Model	Tire designation	Disc wheel designation	Sheet-steel	Light-alloy	Recommended tire makes	Snow chain option
124.061	195/65 R 15 91 T M&S	6.5Jx15 H2 ET 44 6.5Jx15 H2 ET 48 6.5Jx15 H2 ET 49		X X X	CONTINENTAL Winter Contact TS 770 DUNLOP SP Winter Sport M2 MICHELIN XM + S 130 PIRELLI Winter 190 Asimmetrico SEMPERIT Top Grip SLG	yes
	195/65 R 15 91 H M&S	6.5Jx15 H2 ET 44 6.5Jx15 H2 ET 48 6.5Jx15 H2 ET 49	X	X X X	CONTINENTAL Winter Contact TS 790	yes
124.062	195/65 R 15 91 T M&S	6.5Jx15 H2 ET 44 6.5Jx15 H2 ET 48 6.5Jx15 H2 ET 49	X	X X X	CONTINENTAL Winter Contact TS 770 DUNLOP SP Winter Sport M2 MICHELIN XM + S 130 PIRELLI Winter 190 Asimmetrico SEMPERIT Top Grip SLG	yes
	E 22	195/65 R 15 91 T M&S		X X X	CONTINENTAL Winter Contact TS 770 DUNLOP SP Winter Sport M2 MICHELIN XM + S 130 PIRELLI Winter 190 Asimmetrico	yes
E 22	195/65 R 15 91 H M&S	6.5Jx15 H2 ET 44 6.5Jx15 H2 ET 48 6.5Jx15 H2 ET 49	X	X X X	CONTINENTAL Winter Contact TS 790	yes
	E 22	205/60 R 15 91 H M&S		X	CONTINENTAL Winter Contact TS 770 DUNLOP SP Winter Sport M2 PIRELLI Winter 210 Asimmetrico MICHELIN Pilot Alpin	yes
124.066	195/65 R 15 91 T M&S	6.5Jx15 H2 ET 44 6.5Jx15 H2 ET 48 6.5Jx15 H2 ET 49		X X X	CONTINENTAL Winter Contact TS 770 DUNLOP SP Winter Sport M2 MICHELIN XM + S 130 PIRELLI Winter 190 Asimmetrico SEMPERIT Top Grip SLG	yes

2) An entry in the vehicle documents is required in the Federal Republic of Germany when 195/65 R 15 Q or T M + S are used on the 6.5Jx15 H2 ET 44/48/49 disc wheel. Abroad, observe the legislation of the particular country.

4) Only for Scandinavia and countries where spiked tires are permitted. Tire fitted with plastic-coated studs.

5) For retrofitting winter tires only.

Model	Tire designation	Disc wheel designation	Sheet-steel	Light-alloy	Recommended tire makes	Snow chain option
	195/65 R 15 91 H M&S	6.5Jx15 H2 ET 44 6.5Jx15 H2 ET 48 6.5Jx15 H2 ET 49	X	X X X	CONTINENTAL Winter Contact TS 790	yes
124.066 E 32	195/65 R 15 91 T M&S	6.5Jx15 H2 ET 44 6.5Jx15 H2 ET 48 6.5Jx15 H2 ET 49		X X X	CONTINENTAL Winter Contact TS 770 DUNLOP SP Winter Sport M2 MICHELIN XM + S 130 PIRELLI Winter 190 Asimmetrico	yes
	195/65 R 15 91 H M&S	6.5Jx15 H2 ET 44 6.5Jx15 H2 ET 48 6.5Jx15 H2 ET 49	X	X X X	CONTINENTAL Winter Contact TS 790	yes
	205/60 R 15 91 H M&S	7Jx15 H2 ET 41		X	CONTINENTAL Winter Contact TS 770 DUNLOP SP Winter Sport M2 PIRELLI Winter 210 Asimmetrico MICHELIN Pilot Alpin	yes
124.07/08/090	195/65 R 15 91 T M&S	6.5Jx15 H2 ET 44 6.5Jx15 H2 ET 48 6.5Jx15 H2 ET 49	X	X X X	CONTINENTAL Winter Contact TS 770 DUNLOP SP Winter Sport M2 MICHELIN XM + S 130 PIRELLI Winter 190 Asimmetrico SEMPERIT Top Grip SLG	yes
	195/65 R 15 91 H M&S	6.5Jx15 H2 ET 44 6.5Jx15 H2 ET 48 6.5Jx15 H2 ET 49	X	X X X	CONTINENTAL Winter Contact TS 790	yes
124.091/092	195/65 R 15 91 T M&S	6.5Jx15 H2 ET 44 6.5Jx15 H2 ET 48 6.5Jx15 H2 ET 49		X X X	CONTINENTAL Winter Contact TS 770 DUNLOP SP Winter Sport M2 MICHELIN XM + S 130 PIRELLI Winter 190 Asimmetrico SEMPERIT Top Grip SLG	yes

2) An entry in the vehicle documents is required in the Federal Republic of Germany when 195/65 R 15 Q or T M + S are used on the 6.5Jx15 H2 ET 44/48/49 disc wheel. Abroad, observe the legislation of the particular country.

4) Only for Scandinavia and countries where spiked tires are permitted. Tire fitted with plastic-coated studs.

5) For retrofitting winter tires only.



Model	Tire designation	Disc wheel designation	Sheet-steel	Light-alloy	Recommended tire makes	Snow chain option
	195/65 R 15 91 H M&S	6.5Jx15 H2 ET 44 6.5Jx15 H2 ET 48 6.5Jx15 H2 ET 49	X	X X X	CONTINENTAL Winter Contact TS 790	yes
124.104	195/65 R 15 95 T M&S Reinforced	6.5Jx15 H2 ET 48	X	X	CONTINENTAL Winter Contact TS 770	yes
	205/65 R 15 99 S M&S Reinforced	6.5Jx15 H2 ET 48	X	X	CONTINENTAL Winter Contact TS 750	yes
124.105 As of vehicle ident. end no. 1F-163 558	195/65 R 15 95 T M&S Reinforced	6.5Jx15 H2 ET 48	X	X	CONTINENTAL Winter Contact TS 770	yes
As of vehicle ident. end no. 1F-163 558	205/65 R 15 99 S M&S Reinforced	6.5Jx15 H2 ET 48	X	X	CONTINENTAL Winter Contact TS 750	yes
Up to of vehicle ident. end no. 1F- 163 557	195/65 R 15 91 T M&S	6.5Jx15 H2 ET 44 6.5Jx15 H2 ET 48 6.5Jx15 H2 ET 49	X	X X X	CONTINENTAL Winter Contact TS 770 DUNLOP SP Winter Sport M2 MICHELIN XM + S 130 PIRELLI Winter 190 Asimmetrico SEMPERIT Top Grip SLG	yes
Up to of vehicle ident. end no. 1F- 163 557	195/65 R 15 91 H M&S	6.5Jx15 H2 ET 44 6.5Jx15 H2 ET 48 6.5Jx15 H2 ET 49	X	X X X	CONTINENTAL Winter Contact TS 790	yes
124.106 As of vehicle ident. end no. 1F-161 237	195/65 R 15 95 T M&S Reinforced	6.5Jx15 H2 ET 48	X	X	CONTINENTAL Winter Contact TS 770	yes

2) An entry in the vehicle documents is required in the Federal Republic of Germany when 195/65 R 15 Q or T M + S are used on the 6.5Jx15 H2 ET 44/48/49 disc wheel. Abroad, observe the legislation of the particular country.

4) Only for Scandinavia and countries where spiked tires are permitted. Tire fitted with plastic-coated studs.

5) For retrofitting winter tires only.

Model	Tire designation	Disc wheel designation	Sheet-steel	Light-alloy	Recommended tire makes	Snow chain option
As of vehicle ident. end no. 1F-161 237	205/65 R 15 99 S M&S Reinforced	6.5Jx15 H2 ET 48	X	X	CONTINENTAL Winter Contact TS 750	yes
Up to of vehicle ident. end no. 1F-161 236	195/65 R 15 91 T M&S	6.5Jx15 H2 ET 44 6.5Jx15 H2 ET 48 6.5Jx15 H2 ET 49	X	X X X	CONTINENTAL Winter Contact TS 770 DUNLOP SP Winter Sport M2 MICHELIN XM + S 130 PIRELLI Winter 190 Asimmetrico SEMPERIT Top Grip SLG	yes
Up to of vehicle ident. end no. 1F-161 236	195/65 R 15 91 H M&S	6.5Jx15 H2 ET 44 6.5Jx15 H2 ET 48 6.5Jx15 H2 ET 49	X	X X X	CONTINENTAL Winter Contact TS 790	yes
124.107	195/65 R 15 95 T M&S Reinforced	6.5Jx15 H2 ET 48	X	X	CONTINENTAL Winter Contact TS 770	yes
	205/65 R 15 99 S M&S Reinforced	6.5Jx15 H2 ET 48	X	X	CONTINENTAL Winter Contact TS 750	yes
124.120 ²⁾	185/65 R 15 88 T M&S	6Jx15 H2 ET 49	X	X	CONTINENTAL Winter Contact TS 770 DUNLOP SP Winter Sport M2 MICHELIN XM + S 130 PIRELLI Winter 190 Asimmetrico	yes
with suspension for increased payload	195/65 R 15 91 T M&S	6.5Jx15 H2 ET 44 6.5Jx15 H2 ET 48 6.5Jx15 H2 ET 49	X	X X X	CONTINENTAL Winter Contact TS 770 DUNLOP SP Winter Sport M2 MICHELIN XM + S 130 PIRELLI Winter 190 Asimmetrico SEMPERIT Top Grip SLG	yes
	195/65 R 15 91 H M&S	6.5Jx15 H2 ET 44 6.5Jx15 H2 ET 48 6.5Jx15 H2 ET 49	X	X X X	CONTINENTAL Winter Contact TS 790	yes

2) An entry in the vehicle documents is required in the Federal Republic of Germany when 195/65 R 15 Q or T M + S are used on the 6.5Jx15 H2 ET 44/48/49 disc wheel. Abroad, observe the legislation of the particular country.

4) Only for Scandinavia and countries where spiked tires are permitted. Tire fitted with plastic-coated studs.

5) For retrofitting winter tires only.

Model	Tire designation	Disc wheel designation	Sheet-steel	Light-alloy	Recommended tire makes	Snow chain option
124.125/126	195/65 R 15 91 T M&S	6.5Jx15 H2 ET 44 6.5Jx15 H2 ET 48 6.5Jx15 H2 ET 49	X	X X X	CONTINENTAL Winter Contact TS 770 DUNLOP SP Winter Sport M2 MICHELIN XM + S 130 PIRELLI Winter 190 Asimmetrico SEMPERIT Top Grip SLG	yes
	195/65 R 15 91 H M&S	6.5Jx15 H2 ET 44 6.5Jx15 H2 ET 48 6.5Jx15 H2 ET 49	X	X X X	CONTINENTAL Winter Contact TS 790	yes
124.127	205/65 R 15 94 H M&S	6.5Jx15 H2 ET 48 6.5Jx15 H2 ET 49	X	X X	CONTINENTAL Winter Contact TS 770 DUNLOP SP Winter Sport M2 MICHELIN XM + S 330 SEMPERIT Top Grip SLG MICHELIN Pilot Alpin	yes
	205/65 R 15 94 Q M&S	6.5Jx15 H2 ET 48 6.5Jx15 H2 ET 49	X	X X	CONTINENTAL Viking Stop 4000 ⁴⁾	yes
124.128	195/65 R 15 91 T M&S	6.5Jx15 H2 ET 44 6.5Jx15 H2 ET 48 6.5Jx15 H2 ET 49	X	X X X	CONTINENTAL Winter Contact TS 770 DUNLOP SP Winter Sport M2 MICHELIN XM + S 130 PIRELLI Winter 190 Asimmetrico SEMPERIT Top Grip SLG	yes
	195/65 R 15 91 H M&S	6.5Jx15 H2 ET 44 6.5Jx15 H2 ET 48 6.5Jx15 H2 ET 49	X	X X X	CONTINENTAL Winter Contact TS 790	yes
124.129	205/65 R 15 94 H M&S	6.5Jx15 H2 ET 48 6.5Jx15 H2 ET 49	X	X X	CONTINENTAL Winter Contact TS 770 DUNLOP SP Winter Sport M2 MICHELIN XM + S 330 SEMPERIT Top Grip SLG MICHELIN Pilot Alpin	yes

2) An entry in the vehicle documents is required in the Federal Republic of Germany when 195/65 R 15 Q or T M + S are used on the 6.5Jx15 H2 ET 44/48/49 disc wheel. Abroad, observe the legislation of the particular country.

4) Only for Scandinavia and countries where spiked tires are permitted. Tire fitted with plastic-coated studs.

5) For retrofitting winter tires only.



Model	Tire designation	Disc wheel designation	Sheet-steel	Light-alloy	Recommended tire makes	Snow chain option
	205/65 R 15 94 Q M&S	6.5Jx15 H2 ET 48 6.5Jx15 H2 ET 49	X	X X	CONTINENTAL Viking Stop 4000 ⁴⁾	yes
124.13/19/2/3	195/65 R 15 91 T M&S	6.5Jx15 H2 ET 44 6.5Jx15 H2 ET 48 6.5Jx15 H2 ET 49	X	X X X	CONTINENTAL Winter Contact TS 770 DUNLOP SP Winter Sport M2 MICHELIN XM + S 130 PIRELLI Winter 190 Asimmetrico SEMPERIT Top Grip SLG	yes
	195/65 R 15 91 H M&S	6.5Jx15 H2 ET 44 6.5Jx15 H2 ET 48 6.5Jx15 H2 ET 49	X	X X X	CONTINENTAL Winter Contact TS 790	yes

2) An entry in the vehicle documents is required in the Federal Republic of Germany when 195/65 R 15 Q or T M + S are used on the 6.5Jx15 H2 ET 44/48/49 disc wheel. Abroad, observe the legislation of the particular country.

4) Only for Scandinavia and countries where spiked tires are permitted. Tire fitted with plastic-coated studs.

5) For retrofitting winter tires only.

N3 GF40.10-P-1050-01AM	Survey of winter tires/disk wheels/recommended tire makes/snow chains	Model 124 with code 990 AMG vehicles	 GF
----------------------------------	---	--------------------------------------	---

Model	Tire designation	Disc wheel designation	Sheet-steel	Light-alloy	Recommended tire makes	Snow chain option
AMG 124.036 (E60)	225/55 R 16 95 H M&S	8Jx16 H2 ET 34		X	CONTINENTAL Winter Contact TS 770 DUNLOP SP Winter Sport M2	yes
AMG 124.052/066 (E36)	215/55 R 16 91 H M&S	7Jx16 H2 ET 46		X	CONTINENTAL Winter Contact TS 770 DUNLOP SP Winter Sport M2 MICHELIN X M + S 330 PIRELLI Winter 210 Performance PIRELLI Winter 210 Asimmetrico	yes
	225/45 R 17 90 H M&S	7,5Jx17 H2 ET 42		X	CONTINENTAL Winter Contact TS 770 DUNLOP SP Winter Sport M2 MFS MICHELIN X M + S 330 PIRELLI Winter 210 Asimmetrico BRIDGESTONE WT 05	--
AMG 124.092 (E36)	215/55 R 16 91 H M&S	7Jx16 H2 ET 46		X	CONTINENTAL Winter Contact TS 770 DUNLOP SP Winter Sport M2 MICHELIN X M + S 330 PIRELLI Winter 210 Performance PIRELLI Winter 210 Asimmetrico	yes



03	GF40.10-P-1050-01B	Survey of winter tires/disk wheels/recommended tire makes/snow chains	Model 129	 GF
-----------	--------------------	---	-----------	--

Model	Tire designation	Disc wheel designation	Sheet-steel	Light-alloy	Recommended tire makes	Snow chain option
129	245/45 R 17 95 H M&S	8.25Jx17 H2 ET 34		X	DUNLOP SP Winter Sport M2	yes
129 except 129.067	225/55 R 16 95 H M&S	8Jx16 H2 ET 34		X	CONTINENTAL Winter Contact TS 770 DUNLOP SP Winter Sport M2	yes
	225/55 R 16 95 H M&S	8Jx16 H2 ET 35 ⁵⁾	X		CONTINENTAL Winter Contact TS 770 DUNLOP SP Winter Sport M2	yes
129 except MY 98 (code 808) with ESP (code 472)	225/55 R 16 95 H M&S	8Jx16 H2 ET 34		X	CONTINENTAL Winter Contact TS 770 DUNLOP SP Winter Sport M2	yes
	225/55 R 16 95 H M&S	8Jx16 H2 ET 35 ⁵⁾	X		CONTINENTAL Winter Contact TS 770 DUNLOP SP Winter Sport M2	yes
129.067	225/55 R 16 95 H M&S	8Jx16 H2 ET 34		X	CONTINENTAL Winter Contact TS 770 DUNLOP SP Winter Sport M2	yes

5) For retrofitting winter tires only.



P3 GF40.10-P-1050-01BM	Survey of winter tires/disk wheels/recommended tire makes/snow chains	Model 129 with code 990 AMG vehicles	 GF
----------------------------------	---	--------------------------------------	---

Model	Tire designation	Disc wheel designation	Sheet-steel	Light-alloy	Recommended tire makes	Snow chain option
AMG 129.067 (SL60)	225/55 R 16 95 H M&S	8Jx16 H2 ET 34		X	CONTINENTAL Winter Contact TS 770 DUNLOP SP Winter Sport M2	yes
AMG 129.067 (SL60) as of MY 99 (as of code 809)	245/45 R 17 95 H M&S	8.25Jx17 H2 ET 34		X	DUNLOP SP Winter Sport M2	yes



A4	GF40.10-P-1050-01C	Survey of winter tires/disk wheels/recommended tire makes/snow chains	Model 140	GF
-----------	--------------------	---	-----------	----

Model	Tire designation	Disc wheel designation	Sheet-steel	Light-alloy	Recommended tire makes	Snow chain option
140.03 Up to vehicle ident. end no. A-120 931	225/60 R 16 98 H M&S	7.5Jx16 H2 ET 51	X	X	DUNLOP SP Winter Sport M2 PIRELLI Winter 210 Asimmetrico	yes
As of vehicle ident. end no. A-120 932	235/60 R 16 100H M&S	7.5Jx16 H2 ET 51	X	X	CONTINENTAL Winter Contact TS 770 DUNLOP SP Winter Sport M2 PIRELLI Winter 210 Performance Spikes ⁴⁾ PIRELLI Winter 210 Asimmetrico	yes
140 except 140.056/057 /076	235/60 R 16 100H M&S	7.5Jx16 H2 ET 51	X	X	CONTINENTAL Winter Contact TS 770 DUNLOP SP Winter Sport M2 PIRELLI Winter 210 Performance Spikes ⁴⁾ PIRELLI Winter 210 Asimmetrico	yes
140.056/057 /076	235/60 R 16 100H M&S	7.5Jx16 H2 ET 51		X	CONTINENTAL Winter Contact TS 770 DUNLOP SP Winter Sport M2 PIRELLI Winter 210 Performance Spikes ⁴⁾ PIRELLI Winter 210 Asimmetrico	yes
Special protection vehicle	CT 265/40 R 500 114 T 118 Q M&S Reinforced ^{17) 18)}	CT 500x180 A ET 55		X	CONTINENTAL TS 750	yes
Pullmann (not armored)	235/50 R 18 101 H M&S Reinforced	8.5Jx18 H2 ET 47		X	DUNLOP SP Winter Sport M2	

4) Only for Scandinavia and countries where spiked tires are permitted. Tire fitted with plastic-coated studs.

17) The following restrictions due to higher axle load apply to the Pullmann: Maximum speed 160 km/h, maximum kilometerage 10,000 km, effective period of use max. 1 year. When the tread depth is 3 mm, the tire is to be replaced.

18) The following restrictions apply to special protection vehicles: Maximum speed 210 km/h, maximum kilometerage 15,000 km, effective period of use max. 1 year.



The following applies in the event of tire failure: Max. kilometerage 20 km, max. 80 km/h.



B4	GF40.10-P-1050-01GH Survey of winter tires/disk wheels/recommended tire makes/snow chains		 GF
-----------	--	--	--

Model	Tire designation	Disc wheel designation	Sheet-steel	Light-alloy	Recommended tire makes	Snow chain option
163.136/154	225/75 R16 104H M&S	6.5Jx16 H2 ET 47		X	CONTINENTAL General Tire Grabber ST DUNLOP Grand Trek	yes
	255/60 R17 106H M&S	8.5Jx17 H2 ET 52		X	Dunlop SP Winter Sport M2	yes
	255/65 R16 109H M&S	8Jx16 H2 ET 62		X	CONTINENTAL General Tire Grabber ST DUNLOP Grand Trek	yes
	275/55 R17 109H M&S ALL TERRAIN	8.5Jx17 H2 ET 52		X	CONTINENTAL General Tire DUNLOP Grand Trek	yes

C4	GF40.10-P-1050-01GC	Survey of winter tires/disk wheels/recommended tire makes/snow chains	Model 168	 GF
-----------	---------------------	---	-----------	--

Model	Tire designation	Disk wheel designation	Sheet-steel	Light-alloy	Recommended tire makes	Snow chain option
168.007  only	155/70 R 15 78 T M&S	5J x 15 H2 ET 44	X	X	CONTINENTAL Winter Contact TS 760	yes
168.007 except 	185/55 R 15 81 T M&S ⁹⁾	5.5 J x 15 H2 ET54	X	X	CONTINENTAL Winter Contact TS 770 GOODYEAR Ultra Grip 5 PIRELLI Winter 190 Asymmetrico	yes
	185/55 R 15 81 H M&S	5.5 J x 15 H2 ET54	X	X	DUNLOP SP Winter GOODYEAR Eagle Ultra Grip PIRELLI Winter 210 Asymmetrico	yes
168.008/031	185/55 R 15 81 T M&S ⁹⁾	5.5 J x 15 H2 ET54	X	X	CONTINENTAL Winter Contact TS 770 GOODYEAR Ultra Grip 5 PIRELLI Winter 190 Asymmetrico	yes
	185/55 R 15 81 H M&S	5.5 J x 15 H2 ET54	X	X	DUNLOP SP Winter GOODYEAR Eagle Ultra Grip PIRELLI Winter 210 Asymmetrico	yes
168.032	195/50 R 16 84 T MO M&S	5.5 J x 16 H2 ET54	X	X	PIRELLI Winter 210 Asymmetrico	yes
168.033	185/55 R 15 81 T M&S ⁹⁾	5.5 J x 15 H2 ET54	X	X	CONTINENTAL Winter Contact TS 770 GOODYEAR Ultra Grip 5 PIRELLI Winter 190 Asymmetrico	yes
	185/55 R 15 81 H M&S	5.5 J x 15 H2 ET54	X	X	DUNLOP SP Winter GOODYEAR Eagle Ultra Grip PIRELLI Winter 210 Asymmetrico	yes

9) 185/55 R 15 82 T also permissible

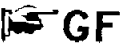

D4	GF40.10-P-1050-01K	Survey of winter tires/disk wheels/recommended tire makes/snow chains	Model 170	 GF
-----------	--------------------	---	-----------	--

Model	Tire designation	Disc wheel designation	Sheet-steel	Light-alloy	Recommended tire makes	Snow chain option
170.435	205/60 R 15 91 H M&S	7Jx15 H2 ET 37	X	X	CONTINENTAL Winter Contact TS 770 DUNLOP SP Winter Sport M2 PIRELLI Winter 210 Asimetrico MICHELIN Pilot Alpin	yes
	205/55 R 16 91 Q M&S	7Jx16 H2 ET 37		X	CONTINENTAL Viking Stop 4000 ⁴⁾	
	205/55 R 16 91 H M&S	7Jx16 H2 ET 37		X	CONTINENTAL Winter Contact TS 770 CONTINENTAL Winter Contact TS 790 MICHELIN Pilot Alpin	yes
170.445/447	205/55 R 16 91 Q M&S	7Jx16 H2 ET 37		X	CONTINENTAL Viking Stop 4000 ⁴⁾	
	205/55 R 16 91 H M&S	7Jx16 H2 ET 37		X	CONTINENTAL Winter Contact TS 770 CONTINENTAL Winter Contact TS 790 MICHELIN Pilot Alpin	yes
170.445/447 ⁶⁾	205/60 R 15 91 H M&S	7Jx15 H2 ET 37	X	X	CONTINENTAL Winter Contact TS 770 DUNLOP SP Winter Sport M2 PIRELLI Winter 210 Asimetrico MICHELIN Pilot Alpin	yes

4) Only for Scandinavian countries

6) Can be retrofitted

E4	GF40.10-P-1050-01D	Survey of winter tires/disk wheels/recommended tire makes/snow chains	Model 201	
-----------	--------------------	---	-----------	---

Model	Tire designation	Disc wheel designation	Sheet-steel	Light-alloy	Recommended tire makes	
201 Sport suspension	205/55 R 15 87 H M&S	7Jx15 H2 ET 42 7Jx15 H2 ET 44	X	X	DUNLOP SP Winter Sport PIRELLI Winter 210 Performance	yes ¹³⁾
201.01/02	185/65 R 15 87 T M&S 185/65 R 15 88 T M&S	6Jx15 H2 ET 49 6.5Jx15 H2 ET 44	X	X X	CONTINENTAL Winter Contact TS 770 DUNLOP SP Winter Sport M2 GOODYEAR Ultra Grip 3 MICHELIN X M + S 130 PIRELLI Winter 190 Performance PIRELLI Winter 190 Asimmetrico UNIROYAL MS Plus 3 SEMPERIT TOP GRIP 65 ³⁾	yes
	185/65 R 15 87 Q M&S	6Jx15 H2 ET 49 6.5Jx15 H2 ET 44	X	X X	GISLAVED NORD FROST 65 Q ⁴⁾	yes
201.036	225/50 R 16 92 H M&S	8Jx16 H2 ET 34 8Jx16 H2 ET 35	X	X	DUNLOP SP Winter Sport	yes
201.12	185/65 R 15 87 T M&S 185/65 R 15 88 T M&S	6Jx15 H2 ET 49 6.5Jx15 H2 ET 44	X	X X	CONTINENTAL Winter Contact TS 770 DUNLOP SP Winter Sport M2 GOODYEAR Ultra Grip 3 MICHELIN X M + S 130 PIRELLI Winter 190 Performance PIRELLI Winter 190 Asimmetrico UNIROYAL MS Plus 3 SEMPERIT TOP GRIP 65 ³⁾	yes
	185/65 R 15 87 Q M&S	6Jx15 H2 ET 49 6.5Jx15 H2 ET 44	X	X X	GISLAVED NORD FROST 65 Q ⁴⁾	yes

3) Tires with spike holes.

4) Only for Scandinavia and countries where spiked tires are permitted. Tire fitted with plastic-coated studs.

13) Only permissible with level control.



F4	GF40.10-P-1050-01E	Survey of winter tires/disk wheels/recommended tire makes/snow chains	Model 202	 GF
-----------	--------------------	---	-----------	--

Model	Tire designation	Disc wheel designation	Sheet-steel	Light-alloy	Recommended tire makes	Snow chain option
202.018/020	185/65 R 15 88 T M&S	6Jx15 H2 ET 31	X		CONTINENTAL Winter Contact TS 770 DUNLOP SP Winter Sport M2 MICHELIN X M+S 130 PIRELLI Winter 190 Asimmetrico	yes
	195/65 R 15 91 Q M&S	6.5Jx15 H2 ET 37	X	X	CONTINENTAL Viking Stop 4000 ⁴⁾ MICHELIN Ivalo ⁴⁾	yes
	195/65 R 15 91 T M&S	6.5Jx15 H2 ET 37	X	X	CONTINENTAL Winter Contact TS 770 DUNLOP SP Winter Sport M2 MICHELIN X M+S 130 PIRELLI Winter 190 Asimmetrico	yes
	195/65 R 15 91 H M&S	6.5Jx15 H2 ET 37	X	X	CONTINENTAL Winter Contact TS 790	yes
	205/60 R 15 91 H M&S	7Jx15 H2 ET 37	X	X	CONTINENTAL Winter Contact TS 770 DUNLOP SP Winter Sport M2 PIRELLI Winter 210 Asimmetrico SEMPERIT Direction Grip MICHELIN Pilot Alpin	yes
	205/55 R 16 91 Q M&S	7Jx16 H2 ET 37		X	CONTINENTAL Viking Stop 4000 ⁴⁾	yes
	205/55 R 16 91 H M&S	7Jx16 H2 ET 37		X	CONTINENTAL Winter Contact TS 770 CONTINENTAL Winter Contact TS 790 DUNLOP SP Winter Sport M2 MICHELIN Pilot Alpin PIRELLI Winter 210 Asimmetrico	yes

4) For Scandinavia only

Model	Tire designation	Disc wheel designation	Sheet-steel	Light-alloy	Recommended tire makes	Snow chain option
202.023/024 /025/026 /028/029 /078/080 /081/082 /083/085 /086/089	195/65 R 15 91 Q M&S	6.5Jx15 H2 ET 37	X	X	CONTINENTAL Viking Stop 4000 ⁴⁾ MICHELIN Ivalo ⁴⁾	yes
	195/65 R 15 91 T M&S	6.5Jx15 H2 ET 37	X	X	CONTINENTAL Winter Contact TS 770 DUNLOP SP Winter Sport M2 MICHELIN X M + S 130 PIRELLI Winter 190 Asimmetrico	yes
	195/65 R 15 91 H M&S	6.5Jx15 H2 ET 37	X	X	CONTINENTAL Winter Contact TS 790	yes
	205/60 R 15 91 H M&S	7Jx15 H2 ET 37	X	X	CONTINENTAL Winter Contact TS 770 DUNLOP SP Winter Sport M2 PIRELLI Winter 210 Asimmetrico SEMPERIT Direction Grip MICHELIN Pilot Alpin	yes
	205/55 R 16 91 Q M&S	7Jx16 H2 ET 37		X	CONTINENTAL Viking Stop 4000 ⁴⁾	yes
	205/55 R 16 91 H M&S	7Jx16 H2 ET 37		X	CONTINENTAL Winter Contact TS 770 CONTINENTAL Winter Contact TS 790 DUNLOP SP Winter Sport M2 MICHELIN Pilot Alpin PIRELLI Winter 210 Asimmetrico	yes
202.12	185/65 R 15 88 T M&S	6Jx15 H2 ET 31	X		CONTINENTAL Winter Contact TS 770 DUNLOP SP Winter Sport M2 MICHELIN X M + S 130 PIRELLI Winter 190 Asimmetrico	yes
202.121/122 /128	195/65 R 15 91 Q M&S	6.5Jx15 H2 ET 37	X	X	CONTINENTAL Viking Stop 4000 ⁴⁾ MICHELIN Ivalo ⁴⁾	yes

4) For Scandinavia only

Model	Tire designation	Disc wheel designation	Sheet-steel	Light-alloy	Recommended tire makes	Snow chain option
	195/65 R 15 91 T M&S	6.5Jx15 H2 ET 37	X	X	CONTINENTAL Winter Contact TS 770 DUNLOP SP Winter Sport M2 MICHELIN X M + S 130 PIRELLI Winter 190 Asimmetrico	yes
	195/65 R 15 91 H M&S	6.5Jx15 H2 ET 37	X	X	CONTINENTAL Winter Contact TS 790	yes
	205/60 R 15 91 H M&S	7Jx15 H2 ET 37	X	X	CONTINENTAL Winter Contact TS 770 DUNLOP SP Winter Sport M2 PIRELLI Winter 210 Asimmetrico SEMPERIT Direction Grip MICHELIN Pilot Alpin	yes
	205/55 R 16 91 Q M&S	7Jx16 H2 ET 37		X	CONTINENTAL Viking Stop 4000 ⁴⁾	yes
	205/55 R 16 91 H M&S	7Jx16 H2 ET 37		X	CONTINENTAL Winter Contact TS 770 CONTINENTAL Winter Contact TS 790 DUNLOP SP Winter Sport M2 MICHELIN Pilot Alpin PIRELLI Winter 210 Asimmetrico	yes
202.133	185/65 R 15 88 T M&S	6Jx15 H2 ET 31	X		CONTINENTAL Winter Contact TS 770 DUNLOP SP Winter Sport M2 MICHELIN X M + S 130 PIRELLI Winter 190 Asimmetrico	yes
	195/65 R 15 91 Q M&S	6.5Jx15 H2 ET 37	X	X	CONTINENTAL Viking Stop 4000 ⁴⁾ MICHELIN Ivalo ⁴⁾	yes
	195/65 R 15 91 T M&S	6.5Jx15 H2 ET 37	X	X	CONTINENTAL Winter Contact TS 770 DUNLOP SP Winter Sport M2 MICHELIN X M + S 130 PIRELLI Winter 190 Asimmetrico	yes
	195/65 R 15 91 H M&S	6.5Jx15 H2 ET 37	X	X	CONTINENTAL Winter Contact TS 790	yes

4) For Scandinavia only

Model	Tire designation	Disc wheel designation	Sheet-steel	Light-alloy	Recommended tire makes	Snow chain option
	205/60 R 15 91 H M&S	7Jx15 H2 ET 37	X	X	CONTINENTAL Winter Contact TS 770 DUNLOP SP Winter Sport M2 PIRELLI Winter 210 Asimmetrico SEMPERIT Direction Grip MICHELIN Pilot Alpin	yes
	205/55 R 16 91 Q M&S	7Jx16 H2 ET 37		X	CONTINENTAL Viking Stop 4000 ⁴⁾	yes
	205/55 R 16 91 H M&S	7Jx16 H2 ET 37		X	CONTINENTAL Winter Contact TS 770 CONTINENTAL Winter Contact TS 790 DUNLOP SP Winter Sport M2 MICHELIN Pilot Alpin PIRELLI Winter 210 Asimmetrico	yes
202.134/180 /182/188 /193/194	195/65 R 15 91 Q M&S	6.5Jx15 H2 ET 37	X	X	CONTINENTAL Viking Stop 4000 ⁴⁾ MICHELIN Ivalo ⁴⁾	yes
	195/65 R 15 91 T M&S	6.5Jx15 H2 ET 37	X	X	CONTINENTAL Winter Contact TS 770 DUNLOP SP Winter Sport M2 MICHELIN X M+ S 130 PIRELLI Winter 190 Asimmetrico	yes
	195/65 R 15 91 H M&S	6.5Jx15 H2 ET 37	X	X	CONTINENTAL Winter Contact TS 790	yes
	205/60 R 15 91 H M&S	7Jx15 H2 ET 37	X	X	CONTINENTAL Winter Contact TS 770 DUNLOP SP Winter Sport M2 PIRELLI Winter 210 Asimmetrico SEMPERIT Direction Grip MICHELIN Pilot Alpin	yes
	205/55 R 16 91 Q M&S	7Jx16 H2 ET 37		X	CONTINENTAL Viking Stop 4000 ⁴⁾	yes
	205/55 R 16 91 H M&S	7Jx16 H2 ET 37		X	CONTINENTAL Winter Contact TS 770 CONTINENTAL Winter Contact TS 790 DUNLOP SP Winter Sport M2 MICHELIN Pilot Alpin PIRELLI Winter 210 Asimmetrico	yes

4) For Scandinavia only



K4	GF40.10-P-1050-01EM	Survey of winter tires/disk wheels/recommended tire makes/snow chains	Model 202 with code 990 AMG vehicles	 GF
-----------	---------------------	---	--------------------------------------	---

Model	Tire designation	Disc wheel designation	Sheet-steel	Light-alloy	Recommended tire makes	Snow chain option
202 (with retrofitted assembly)	225/45 R 17 90 H M&S	7.5Jx17 ET 35		X	CONTINENTAL Winter Contact TS 770 DUNLOP SP Winter Sport M2 MFS MICHELIN X M + S 330 PIRELLI Winter 210 Asimmetrico BRIDGESTONE WT 05	--
AMG 202.028 (C36)	215/45 R 17 87 H M&S	7.5Jx17 ET 35		X	MICHELIN X M + S 330 PIRELLI Winter 210 Asimmetrico	yes
	225/45 R 17 90 H M&S	7.5Jx17 ET 35		X	CONTINENTAL Winter Contact TS 770 DUNLOP SP Winter Sport M2 MFS MICHELIN X M + S 330 PIRELLI Winter 210 Asimmetrico BRIDGESTONE WT 05	--
	225/45 R 17 90 H M&S	7.5Jx17 ET 37		X	CONTINENTAL Winter Contact TS 770 DUNLOP SP Winter Sport M2 MFS MICHELIN X M + S 330 PIRELLI Winter 210 Asimmetrico BRIDGESTONE WT 05	--
AMG 202.033/093 (C43)	215/45 R 17 87 H M&S	7.5Jx17 ET 35		X	MICHELIN X M + S 330 PIRELLI Winter 210 Asimmetrico	yes
	225/45 R 17 90 H M&S	7.5Jx17 ET 35		X	CONTINENTAL Winter Contact TS 770 DUNLOP SP Winter Sport M2 MFS MICHELIN X M + S 330 PIRELLI Winter 210 Asimmetrico BRIDGESTONE WT 05	--

Model	Tire designation	Disc wheel designation	Sheet-steel	Light-alloy	Recommended tire makes	Snow chain option
	225/45 R 17 90 H M&S	7.5Jx17 ET 37		X	CONTINENTAL Winter Contact TS 770 DUNLOP SP Winter Sport M2 MFS MICHELIN X M + S 330 PIRELLI Winter 210 Asimmetrico BRIDGESTONE WT 05	--



M4	GF40.10-P-1050-010	Survey of winter tires/disk wheels/recommended tire makes/snow chains	Model 208	 GF
-----------	--------------------	---	-----------	---

7) Provisionally available as of 2nd quarter '99

Model	Tire designation	Disc wheel designation	Sheet-steel	Light-alloy	Recommended tire makes	Snow chain option
208.335/345/347	195/65 R 15 91 T M&S	6.5J x 15 H2 ET 37	X	X	CONTINENTAL Winter Contact TS 770 DUNLOP SP Winter Sport M2 MICHELIN X M + S 130 PIRELLI Winter 190 Asimmetrico	yes
	195/65 R 15 91 H M&S	6.5J x 15 H2 ET 37	X	X	CONTINENTAL Winter Contact TS 790	yes
	205/60 R 15 91 H M&S	7J x 15 H2 ET 37	X	X	CONTINENTAL Winter Contact TS 770 DUNLOP SP Winter Sport M2 PIRELLI Winter 210 Asimmetrico SEMPERIT Direction Grip MICHELIN Pilot Alpin	yes
	205/55 R 16 91 Q M&S	7J x 16 H2 ET 37	X ⁷⁾	X	CONTINENTAL Viking Stop 4000 ⁴⁾	yes
	205/55 R 16 91 H M&S	7J x 16 H2 ET 37	X ⁷⁾	X	CONTINENTAL Winter Contact TS 770 CONTINENTAL Winter Contact TS 790 DUNLOP SP Winter Sport M2 MICHELIN Pilot Alpin PIRELLI Winter 210 Asimmetrico	yes
208.365/370	205/55 R 16 91 Q M&S	7J x 16 H2 ET 37	X ⁷⁾	X	CONTINENTAL Viking Stop 4000 ⁴⁾	yes
	205/55 R 16 91 H M&S	7J x 16 H2 ET 37	X ⁷⁾	X	CONTINENTAL Winter Contact TS 770 CONTINENTAL Winter Contact TS 790 DUNLOP SP Winter Sport M2 MICHELIN Pilot Alpin PIRELLI Winter 210 Asimmetrico	yes
208.435	195/65 R 15 91 T M&S	6.5J x 15 H2 ET 37	X	X	CONTINENTAL Winter Contact TS 770 DUNLOP SP Winter Sport M2 MICHELIN X M + S 130 PIRELLI Winter 190 Asimmetrico	yes

4) Only for Scandinavian countries

Model	Tire designation	Disc wheel designation	Sheet-steel	Light-alloy	Recommended tire makes	Snow chain option
	195/65 R 15 91 H M&S	6.5J x 15 H2 ET 37	X	X	CONTINENTAL Winter Contact TS 790	yes
	205/60 R 15 91 H M&S	7J x 15 H2 ET 37	X	X	CONTINENTAL Winter Contact TS 770 DUNLOP SP Winter Sport M2 PIRELLI Winter 210 Asimmetrico SEMPERIT Direction Grip MICHELIN Pilot Alpin	yes
	205/55 R 16 91 Q M&S	7J x 16 H2 ET 37	X ⁴⁾	X	CONTINENTAL Viking Stop 4000 ⁴⁾	yes
	205/55 R 16 91 H M&S	7J x 16 H2 ET 37	X ⁴⁾	X	CONTINENTAL Winter Contact TS 770 CONTINENTAL Winter Contact TS 790 DUNLOP SP Winter Sport M2 MICHELIN Pilot Alpin PIRELLI Winter 210 Asimmetrico	yes
208.445/447 /465/470	205/55 R 16 91 Q M&S	7J x 16 H2 ET 37	X ⁴⁾	X	CONTINENTAL Viking Stop 4000 ⁴⁾	yes
	205/55 R 16 91 H M&S	7J x 16 H2 ET 37	X ⁴⁾	X	CONTINENTAL Winter Contact TS 770 CONTINENTAL Winter Contact TS 790 DUNLOP SP Winter Sport M2 MICHELIN Pilot Alpin PIRELLI Winter 210 Asimmetrico	yes

4) Only for Scandinavian countries



04	GF40.10-P-1050-01F	Survey of winter tires/disk wheels/recommended tire makes/snow chains	Model 210	GF
-----------	--------------------	---	-----------	-----------

Model	Tire designation	Disc wheel designation	Sheet-steel	Light-alloy	Recommended tire makes	Snow chain option
210.003/004 /006/007 /010	195/65 R 15 91 Q M&S	6.5Jx15 H2 ET 37	X	X	CONTINENTAL Viking Stop 4000 ⁴⁾ MICHELIN Ivalo ⁴⁾	yes
	195/65 R 15 91 T M&S	6.5Jx15 H2 ET 37	X	X	CONTINENTAL Winter Contact TS 770 DUNLOP SP Winter Sport M2 MICHELIN X M + S 130 PIRELLI Winter 190 Asimmetrico	yes
	195/65 R 15 91 H M&S	6.5Jx15 H2 ET 37	X	X	CONTINENTAL Winter Contact TS 790	yes
	205/65 R 15 94 Q M&S	7Jx15 H2 ET 37	X	X	CONTINENTAL Viking Stop 4000 ⁴⁾	yes
	205/65 R 15 94 H M&S	7Jx15 H2 ET 37	X	X	CONTINENTAL Winter Contact TS 770 DUNLOP SP Winter Sport M2 MICHELIN X M + S 330 MICHELIN Pilot Alpin SEMPERIT Top Grip	yes
	215/55 R 16 93 Q M&S	7.5Jx16 H2 ET 41	X	X	CONTINENTAL Viking Stop 4000 ⁴⁾	yes
	215/55 R 16 93 H M&S	7.5Jx16 H2 ET 41	X	X	CONTINENTAL Winter Contact TS 770 DUNLOP SP Winter Sport M2 MICHELIN X M + S 330 MICHELIN Pilot Alpin PIRELLI Winter 210 Asimmetrico SEMPERIT Direction Grip	yes
	235/45 R 17 93 H M&S 235/45 R 17 94 H M&S	8Jx17 H2 ET 37		X	CONTINENTAL Winter Contact TS 770 PIRELLI Winter 210 Asimmetrico	yes

3) Not in conjunction with ESP

4) For Scandinavia only

Model	Tire designation	Disc wheel designation	Sheet-steel	Light-alloy	Recommended tire makes	Snow chain option
210.015	205/65 R 15 94 H M&S	7Jx15 H2 ET 37	X	X	CONTINENTAL Winter Contact TS 770 DUNLOP SP Winter Sport M2 MICHELIN X M + S 330 MICHELIN Pilot Alpin SEMPERIT Top Grip	yes
	215/55 R 16 93 Q M&S	7.5Jx16 H2 ET 41	X	X	CONTINENTAL Viking Stop 4000 ⁴⁾	yes
	215/55 R 16 93 H M&S	7.5Jx16 H2 ET 41	X	X	CONTINENTAL Winter Contact TS 770 DUNLOP SP Winter Sport M2 MICHELIN X M + S 330 MICHELIN Pilot Alpin PIRELLI Winter 210 Asimmetrico SEMPERIT Direction Grip	yes
	235/45 R 17 93 H M&S 235/45 R 17 94 H M&S	8Jx17 H2 ET 37		X	CONTINENTAL Winter Contact TS 770 PIRELLI Winter 210 Asimmetrico	yes
210.017/020	195/65 R 15 91 Q M&S	6.5Jx15 H2 ET 37	X	X	CONTINENTAL Viking Stop 4000 ⁴⁾ MICHELIN Ivalo ⁴⁾	yes
	195/65 R 15 91 T M&S	6.5Jx15 H2 ET 37	X	X	CONTINENTAL Winter Contact TS 770 DUNLOP SP Winter Sport M2 MICHELIN X M + S 130 PIRELLI Winter 190 Asimmetrico	yes
	195/65 R 15 91 H M&S	6.5Jx15 H2 ET 37	X	X	CONTINENTAL Winter Contact TS 790	yes
	205/65 R 15 94 Q M&S	7Jx15 H2 ET 37	X	X	CONTINENTAL Viking Stop 4000 ⁴⁾	yes
	205/65 R 15 94 H M&S	7Jx15 H2 ET 37	X	X	CONTINENTAL Winter Contact TS 770 DUNLOP SP Winter Sport M2 MICHELIN X M + S 330 MICHELIN Pilot Alpin SEMPERIT Top Grip	yes
	215/55 R 16 93 Q M&S	7.5Jx16 H2 ET 41	X	X	CONTINENTAL Viking Stop 4000 ⁴⁾	yes

3) Not in conjunction with ESP

4) For Scandinavia only

Model	Tire designation	Disc wheel designation	Sheet-steel	Light-alloy	Recommended tire makes	Snow chain option
	215/55 R 16 93 H M&S	7.5Jx16 H2 ET 41	X	X	CONTINENTAL Winter Contact TS 770 DUNLOP SP Winter Sport M2 MICHELIN X M + S 330 MICHELIN Pilot Alpin PIRELLI Winter 210 Asimmetrico SEMPERIT Direction Grip	yes
	235/45 R 17 93 H M&S 235/45 R 17 94 H M&S	8Jx17 H2 ET 37		X	CONTINENTAL Winter Contact TS 770 PIRELLI Winter 210 Asimmetrico	yes
210.025	215/55 R 16 93 Q M&S	7.5Jx16 H2 ET 41	X	X	CONTINENTAL Viking Stop 4000 ⁴⁾	yes
	215/55 R 16 93 H M&S	7.5Jx16 H2 ET 41	X	X	CONTINENTAL Winter Contact TS 770 DUNLOP SP Winter Sport M2 MICHELIN X M + S 330 MICHELIN Pilot Alpin PIRELLI Winter 210 Asimmetrico SEMPERIT Direction Grip	yes
	235/45 R 17 93 H M&S 235/45 R 17 94 H M&S	8Jx17 H2 ET 37		X	CONTINENTAL Winter Contact TS 770 PIRELLI Winter 210 Asimmetrico	yes
210.035/037	195/65 R 15 91 Q M&S	6.5Jx15 H2 ET 37	X	X	CONTINENTAL Viking Stop 4000 ⁴⁾ MICHELIN Ivalo ⁴⁾	yes
	195/65 R 15 91 T M&S	6.5Jx15 H2 ET 37	X	X	CONTINENTAL Winter Contact TS 770 DUNLOP SP Winter Sport M2 MICHELIN X M + S 130 PIRELLI Winter 190 Asimmetrico	yes
	195/65 R 15 91 H M&S	6.5Jx15 H2 ET 37	X	X	CONTINENTAL Winter Contact TS 790	yes
	205/65 R 15 94 Q M&S	7Jx15 H2 ET 37	X	X	CONTINENTAL Viking Stop 4000 ⁴⁾	yes
	205/65 R 15 94 H M&S	7Jx15 H2 ET 37	X	X	CONTINENTAL Winter Contact TS 770 DUNLOP SP Winter Sport M2 MICHELIN X M + S 330 MICHELIN Pilot Alpin SEMPERIT Top Grip	yes

3) Not in conjunction with ESP

4) For Scandinavia only

Model	Tire designation	Disc wheel designation	Sheet-steel	Light-alloy	Recommended tire makes	Snow chain option
	215/55 R 16 93 Q M&S	7.5Jx16 H2 ET 41	X	X	CONTINENTAL Viking Stop 4000 ⁴⁾	yes
	215/55 R 16 93 H M&S	7.5Jx16 H2 ET 41	X	X	CONTINENTAL Winter Contact TS 770 DUNLOP SP Winter Sport M2 MICHELIN X M + S 330 MICHELIN Pilot Alpin PIRELLI Winter 210 Asimmetrico SEMPERIT Direction Grip	yes
	235/45 R 17 93 H M&S 235/45 R 17 94 H M&S	8Jx17 H2 ET 37		X	CONTINENTAL Winter Contact TS 770 PIRELLI Winter 210 Asimmetrico	yes
210.045	215/55 R 16 93 Q M&S	7.5Jx16 H2 ET 41	X	X	CONTINENTAL Viking Stop 4000 ⁴⁾	yes
	215/55 R 16 93 H M&S	7.5Jx16 H2 ET 41	X	X	CONTINENTAL Winter Contact TS 770 DUNLOP SP Winter Sport M2 MICHELIN X M + S 330 MICHELIN Pilot Alpin PIRELLI Winter 210 Asimmetrico SEMPERIT Direction Grip	yes
	235/45 R 17 93 H M&S 235/45 R 17 94 H M&S	8Jx17 H2 ET 37		X	CONTINENTAL Winter Contact TS 770 PIRELLI Winter 210 Asimmetrico	yes
210.053/055	215/55 R 16 93 Q M&S	7.5Jx16 H2 ET 41	X	X	CONTINENTAL Viking Stop 4000 ⁴⁾	yes
	215/55 R 16 93 H M&S	7.5Jx16 H2 ET 41	X	X	CONTINENTAL Winter Contact TS 770 DUNLOP SP Winter Sport M2 MICHELIN X M + S 330 MICHELIN Pilot Alpin PIRELLI Winter 210 Asimmetrico SEMPERIT Direction Grip	yes
210.061	195/65 R 15 91QM&S ³⁾	6.5Jx15 H2 ET 37	X	X	CONTINENTAL Viking Stop 4000 ⁴⁾ MICHELIN Ivalo ⁴⁾	yes

3) Not in conjunction with ESP

4) For Scandinavia only

Model	Tire designation	Disc wheel designation	Sheet-steel	Light-alloy	Recommended tire makes	Snow chain option
	195/65 R 15 91 TM&S ³⁾	6.5Jx15 H2 ET 37	X	X	CONTINENTAL Winter Contact TS 770 DUNLOP SP Winter Sport M2 MICHELIN X M + S 130 PIRELLI Winter 190 Asimmetrico	yes
	195/65 R 15 91 HM&S ³⁾	6.5Jx15 H2 ET 37	X	X	CONTINENTAL Winter Contact TS 790	yes
	205/65 R 15 94QM&S ³⁾	7Jx15 H2 ET 37	X	X	CONTINENTAL Viking Stop 4000 ⁴⁾	yes
	205/65 R 15 94H M&S ³⁾	7Jx15 H2 ET 37	X	X	CONTINENTAL Winter Contact TS 770 DUNLOP SP Winter Sport M2 MICHELIN X M + S 330 MICHELIN Pilot Alpin SEMPERIT Top Grip	yes
	215/55 R 16 93 Q M&S	7.5Jx16 H2 ET 41	X	X	CONTINENTAL Viking Stop 4000 ⁴⁾	yes
	215/55 R 16 93 H M&S	7.5Jx16 H2 ET 41	X	X	CONTINENTAL Winter Contact TS 770 DUNLOP SP Winter Sport M2 MICHELIN X M + S 330 MICHELIN Pilot Alpin PIRELLI Winter 210 Asimmetrico SEMPERIT Direction Grip	yes
	235/45 R 17 93 H M&S 235/45 R 17 94 H M&S	8Jx17 H2 ET 37		X	CONTINENTAL Winter Contact TS 770 PIRELLI Winter 210 Asimmetrico	yes
210.063/065	215/55 R 16 93 Q M&S	7.5Jx16 H2 ET 41	X	X	CONTINENTAL Viking Stop 4000 ⁴⁾	yes
	215/55 R 16 93 H M&S	7.5Jx16 H2 ET 41	X	X	CONTINENTAL Winter Contact TS 770 DUNLOP SP Winter Sport M2 MICHELIN X M + S 330 MICHELIN Pilot Alpin PIRELLI Winter 210 Asimmetrico SEMPERIT Direction Grip	yes
	235/45 R 17 93 H M&S 235/45 R 17 94 H M&S	8Jx17 H2 ET 37		X	CONTINENTAL Winter Contact TS 770 PIRELLI Winter 210 Asimmetrico	--

3) Not in conjunction with ESP

4) For Scandinavia only

Model	Tire designation	Disc wheel designation	Sheet-steel	Light-alloy	Recommended tire makes	Snow chain option
210.065/070 /072 Special protection (B4)	215/55 R 16 93 Q M&S	7.5Jx16 H2 ET 41		X	CONTINENTAL Viking Stop 4000 ⁴⁾	yes
	215/55 R 16 93 H M&S	7.5Jx16 H2 ET 41		X	CONTINENTAL Winter Contact TS 770 DUNLOP SP Winter Sport M2 MICHELIN X M + S 330 MICHELIN Pilot Alpin PIRELLI Winter 210 Asimmetrico SEMPERIT Direction Grip	yes
	225/55 R 16 99 H M&S Reinforced	7.5Jx16 H2 ET 38		X	PIRELLI Winter 210 Performance	yes
210.070/072	215/55 R 16 93 Q M&S	7.5Jx16 H2 ET 41	X	X	CONTINENTAL Viking Stop 4000 ⁴⁾	yes
	215/55 R 16 93 H M&S	7.5Jx16 H2 ET 41		X	CONTINENTAL Winter Contact TS 770 DUNLOP SP Winter Sport M2 MICHELIN X M + S 330 MICHELIN Pilot Alpin PIRELLI Winter 210 Asimmetrico SEMPERIT Direction Grip	yes
	235/45 R 17 93 H M&S 235/45 R 17 94 H M&S	8Jx17 H2 ET 37		X	CONTINENTAL Winter Contact TS 770 PIRELLI Winter 210 Asimmetrico	--
	Special protection (B6)	225/55 R 16 99 H M&S Reinforced	7.5Jx16 H2 ET 38		X	PIRELLI Winter 210 Performance
Special protection (B6)	CT 225/40 R475 102H Reinforced	CT 475x180 ET 34		X	CONTINENTAL Winter Contact TS 750	--
210.081/082	215/55 R 16 93 Q M&S	7.5Jx16 H2 ET 41	X	X	CONTINENTAL Viking Stop 4000 ⁴⁾	yes

3) Not in conjunction with ESP

4) For Scandinavia only



Model	Tire designation	Disc wheel designation	Sheet-steel	Light-alloy	Recommended tire makes	Snow chain option
	215/55 R 16 93 H M&S	7.5Jx16 H2 ET 41	X	X	CONTINENTAL Winter Contact TS 770 DUNLOP SP Winter Sport M2 MICHELIN X M + S 330 MICHELIN Pilot Alpin PIRELLI Winter 210 Asimmetrico SEMPERIT Direction Grip	yes
	235/45 R 17 93 H M&S 235/45 R 17 94 H M&S	8Jx17 H2 ET 37		X	CONTINENTAL Winter Contact TS 770 PIRELLI Winter 210 Asimmetrico	yes
210.083 As of MY 99/1	235/45 R 17 93 H M&S 235/45 R 17 94 H M&S	8Jx17 H2 ET 37		X	CONTINENTAL Winter Contact TS 770 PIRELLI Winter 210 Asimmetrico	yes
210.206/210 /215/217	205/65 R 15 94 Q M&S	7Jx15 H2 ET 37	X	X	CONTINENTAL Viking Stop 4000 ⁴⁾	yes
	205/65 R 15 94 H M&S	7Jx15 H2 ET 37	X	X	CONTINENTAL Winter Contact TS 770 DUNLOP SP Winter Sport M2 MICHELIN X M + S 330 MICHELIN Pilot Alpin SEMPERIT Top Grip	yes
	215/55 R 16 93 Q M&S	7.5Jx16 H2 ET 41	X	X	CONTINENTAL Viking Stop 4000 ⁴⁾	yes
	215/55 R 16 93 H M&S	7.5Jx16 H2 ET 41	X	X	CONTINENTAL Winter Contact TS 770 DUNLOP SP Winter Sport M2 MICHELIN X M + S 330 MICHELIN Pilot Alpin PIRELLI Winter 210 Asimmetrico SEMPERIT Direction Grip	yes
	235/45 R 17 93 H M&S 235/45 R 17 94 H M&S	8Jx17 H2 ET 37		X	CONTINENTAL Winter Contact TS 770 PIRELLI Winter 210 Asimmetrico	yes
210.225	215/55 R 16 93 Q M&S	7.5Jx16 H2 ET 41	X	X	CONTINENTAL Viking Stop 4000 ⁴⁾	yes

3) Not in conjunction with ESP

4) For Scandinavia only

Model	Tire designation	Disc wheel designation	Sheet-steel	Light-alloy	Recommended tire makes	Snow chain option
	215/55 R 16 93 H M&S	7.5Jx16 H2 ET 41	X	X	CONTINENTAL Winter Contact TS 770 DUNLOP SP Winter Sport M2 MICHELIN X M + S 330 MICHELIN Pilot Alpin PIRELLI Winter 210 Asimmetrico SEMPERIT Direction Grip	yes
	235/45 R 17 93 H M&S 235/45 R 17 94 H M&S	8Jx17 H2 ET 37		X	CONTINENTAL Winter Contact TS 770 PIRELLI Winter 210 Asimmetrico	yes
210.235/237	205/65 R 15 94 Q M&S	7Jx15 H2 ET 37	X	X	CONTINENTAL Viking Stop 4000 ⁴⁾	yes
	205/65 R 15 94 H M&S	7Jx15 H2 ET 37	X	X	CONTINENTAL Winter Contact TS 770 DUNLOP SP Winter Sport M2 MICHELIN X M + S 330 MICHELIN Pilot Alpin SEMPERIT Top Grip	yes
	215/55 R 16 93 Q M&S	7.5Jx16 H2 ET 41	X	X	CONTINENTAL Viking Stop 4000 ⁴⁾	yes
	215/55 R 16 93 H M&S	7.5Jx16 H2 ET 41	X	X	CONTINENTAL Winter Contact TS 770 DUNLOP SP Winter Sport M2 MICHELIN X M + S 330 MICHELIN Pilot Alpin PIRELLI Winter 210 Asimmetrico SEMPERIT Direction Grip	yes
	235/45 R 17 93 H M&S 235/45 R 17 94 H M&S	8Jx17 H2 ET 37		X	CONTINENTAL Winter Contact TS 770 PIRELLI Winter 210 Asimmetrico	yes
210.245	215/55 R 16 93 Q M&S	7.5Jx16 H2 ET 41	X	X	CONTINENTAL Viking Stop 4000 ⁴⁾	yes
	215/55 R 16 93 H M&S	7.5Jx16 H2 ET 41	X	X	CONTINENTAL Winter Contact TS 770 DUNLOP SP Winter Sport M2 MICHELIN X M + S 330 MICHELIN Pilot Alpin PIRELLI Winter 210 Asimmetrico SEMPERIT Direction Grip	yes

3) Not in conjunction with ESP

4) For Scandinavia only

Model	Tire designation	Disc wheel designation	Sheet-steel	Light-alloy	Recommended tire makes	Snow chain option
	235/45 R 17 93 H M&S 235/45 R 17 94 H M&S	8Jx17 H2 ET 37		X	CONTINENTAL Winter Contact TS 770 PIRELLI Winter 210 Asimmetrico	yes
210.261	205/65 R 15 94Q M&S ³⁾	7Jx15 H2 ET 37	X	X	CONTINENTAL Viking Stop 4000 ⁴⁾	yes
	205/65 R 15 94H M&S ³⁾	7Jx15 H2 ET 37	X	X	CONTINENTAL Winter Contact TS 770 DUNLOP SP Winter Sport M2 MICHELIN X M + S 330 MICHELIN Pilot Alpin SEMPERIT Top Grip	yes
	215/55 R 16 93 Q M&S	7.5Jx16 H2 ET 41	X	X	CONTINENTAL Viking Stop 4000 ⁴⁾	yes
	215/55 R 16 93 H M&S	7.5Jx16 H2 ET 41	X	X	CONTINENTAL Winter Contact TS 770 DUNLOP SP Winter Sport M2 MICHELIN X M + S 330 MICHELIN Pilot Alpin PIRELLI Winter 210 Asimmetrico SEMPERIT Direction Grip	yes
	235/45 R 17 93 H M&S 235/45 R 17 94 H M&S	8Jx17 H2 ET 37		X	CONTINENTAL Winter Contact TS 770 PIRELLI Winter 210 Asimmetrico	yes
210.265 /270/272 /281/282	215/55 R 16 93 Q M&S	7.5Jx16 H2 ET 41	X	X	CONTINENTAL Viking Stop 4000 ⁴⁾	yes
	215/55 R 16 93 H M&S	7.5Jx16 H2 ET 41	X	X	CONTINENTAL Winter Contact TS 770 DUNLOP SP Winter Sport M2 MICHELIN X M + S 330 MICHELIN Pilot Alpin PIRELLI Winter 210 Asimmetrico SEMPERIT Direction Grip	yes
	235/45 R 17 93 H M&S 235/45 R 17 94 H M&S	8Jx17 H2 ET 37		X	CONTINENTAL Winter Contact TS 770 PIRELLI Winter 210 Asimmetrico	yes
210.270/272	215/55 R 16 93 Q M&S	7.5Jx16 H2 ET 41		X	CONTINENTAL Viking Stop 4000 ⁴⁾	yes

3) Not in conjunction with ESP

4) For Scandinavia only

Model	Tire designation	Disc wheel designation	Sheet-steel	Light-alloy	Recommended tire makes	Snow chain option
	215/55 R 16 93 H M&S	7.5Jx16 H2 ET 41		X	CONTINENTAL Winter Contact TS 770 DUNLOP SP Winter Sport M2 MICHELIN X M + S 330 MICHELIN Pilot Alpin PIRELLI Winter 210 Asimmetrico SEMPERIT Direction Grip	yes
	235/45 R 17 93 H M&S 235/45 R 17 94 H M&S	8Jx17 H2 ET 37		X	CONTINENTAL Winter Contact TS 770 PIRELLI Winter 210 Asimmetrico	yes
210.281/282	215/55 R 16 93 Q M&S	7.5Jx16 H2 ET 41	X	X	CONTINENTAL Viking Stop 4000 ⁴⁾	yes
	215/55 R 16 93 H M&S	7.5Jx16 H2 ET 41	X	X	CONTINENTAL Winter Contact TS 770 DUNLOP SP Winter Sport M2 MICHELIN X M + S 330 MICHELIN Pilot Alpin PIRELLI Winter 210 Asimmetrico SEMPERIT Direction Grip	yes
	235/45 R 17 93 H M&S 235/45 R 17 94 H M&S	8Jx17 H2 ET 37		X	CONTINENTAL Winter Contact TS 770 PIRELLI Winter 210 Asimmetrico	yes
210.283 As of MY 99/1	235/45 R 17 93 H M&S 235/45 R 17 94 H M&S	8Jx17 H2 ET 37		X	CONTINENTAL Winter Contact TS 770 PIRELLI Winter 210 Asimmetrico	yes
210.606/610 /617/663	225/55 R 16 99 H M&S Reinforced	7.5Jx16 H2 ET 38	X	X	PIRELLI Winter 210 Performance	yes

3) Not in conjunction with ESP

4) For Scandinavia only

J5	GF40.10-P-1050-01FM	Survey of winter tires/disk wheels/recommended tire makes/snow chains	Model 210 with code 990 AMG vehicles	 GF
-----------	---------------------	---	--------------------------------------	---

Model	Tire designation	Disc wheel designation	Sheet-steel	Light-alloy	Recommended tire makes	Snow chain option
AMG 210.055 (E36 RL)	215/55 R 16 93 H M&S	7.5 J x 16 H2 ET 41		X	CONTINENTAL Winter Contact TS 770 DUNLOP SP Winter Sport M2 MICHELIN X M + S 330 PIRELLI Winter 210 Asimmetrico SEMPERIT Direction Grip	yes
AMG 210.072 (E50) 210.074 (E55) 210.274 (E55)	235/45 R 17 93 H M&S	7.5 J x 17 H2 ET 35		X	CONTINENTAL Winter Contact TS 770 DUNLOP SP Winter Sport M2 MFS MICHELIN X M + S 330 BRIDGESTONE WT 05	yes
AMG 210.074 (E55) 210.274 (E55)	235/45 R 17 93 H M&S	8 J x 17 H2 ET 37		X	CONTINENTAL Winter Contact TS 770 DUNLOP SP Winter Sport M2 MFS MICHELIN X M + S 330 BRIDGESTONE WT 05	yes



K5	GF40.10-P-1050-01P	Survey of winter tires/disk wheels/recommended tire makes/snow chains	Model 220	 GF
-----------	--------------------	---	-----------	---

Model	Tire designation	Disk wheel designation	Sheet-steel	Light-alloy	Recommended tire makes	Snow chain option
220.026/063 /065/070 /075/128 /165/170 /175	225/60 R 16 98 H M&S	7.5Jx16 H2 ET 46		X	CONTINENTAL Winter Contact TS 770 DUNLOP Winter Sport M2 PIRELLI Winter 210 Asimmetrico	
	225/55 R 17 97 H M&S	7.5Jx17 H2 ET 46		X	PIRELLI Winter 210 Asimmetrico	
220.178	225/55 R 17 97 H M&S	7.5Jx17 H2 ET 46		X	PIRELLI Winter 210 Asimmetrico	

L5	GF40.10-P-1050-02A	Survey of summer tires/disc wheels/recommended tire makes	Model 124	
-----------	--------------------	---	-----------	---

Model	Tire designation	Disc wheel designation	Sheet-steel	Light-alloy	Recommended tire makes
124.003 up to vehicle ident. end no. F-163557	195/65 R 15 91 T	6.5Jx15 H2 ET 44 6.5Jx15 H2 ET 48 6.5Jx15 H2 ET 49 6.5Jx15 H2 ET 49 Reinforced	X	X X X	DUNLOP SP 65 GOODYEAR GT 2 MICHELIN MXT MICHELIN MXT Energy PIRELLI P6000
as of vehicle ident. end no. F-163558	195/65 R 15 95 T Reinforced	6.5Jx15 H2 ET 48 6.5Jx15 H2 ET 49	X	X	CONTINENTAL CT 22
as of vehicle ident. end no. F-163558	205/65 R 15 99 T Reinforced ³⁾	6.5Jx15 H2 ET 48 6.5Jx15 H2 ET 49	X	X	CONTINENTAL CT 22
124.004 up to vehicle ident. end no. F-161236	195/65 R 15 91 T	6.5Jx15 H2 ET 44 6.5Jx15 H2 ET 48 6.5Jx15 H2 ET 49 6.5Jx15 H2 ET 49 Reinforced	X	X X X	DUNLOP SP 65 GOODYEAR GT 2 MICHELIN MXT MICHELIN MXT Energy PIRELLI P6000
as of vehicle ident. end no. F-161237	195/65 R 15 95 T Reinforced	6.5Jx15 H2 ET 48 6.5Jx15 H2 ET 49	X	X	UNIROYAL Rallye 340/65
as of vehicle ident. end no. F-161237	205/65 R 15 99 T Reinforced ³⁾	6.5Jx15 H2 ET 48 6.5Jx15 H2 ET 49	X	X	CONTINENTAL CT 22
124.007 up to vehicle ident. end no. F-161236	195/65 R 15 91 T	6.5Jx15 H2 ET 44 6.5Jx15 H2 ET 48 6.5Jx15 H2 ET 49 6.5Jx15 H2 ET 49 Reinforced	X	X X X	DUNLOP SP 65 GOODYEAR GT 2 MICHELIN MXT MICHELIN MXT Energy PIRELLI P6000

1) Also permissible: 225/55 ZR 16 95 W or 225/55 R16 95W

3) Entry in vehicle documents required

Model	Tire designation	Disc wheel designation	Sheet-steel	Light-alloy	Recommended tire makes
as of vehicle ident. end no. F-161237	195/65 R 15 95 T Reinforced	6.5Jx15 H2 ET 48 6.5Jx15 H2 ET 49	X	X	UNIROYAL Rallye 340/65
as of vehicle ident. end no. F-161237	205/65 R 15 99 T Reinforced ³⁾	6.5Jx15 H2 ET 48 6.5Jx15 H2 ET 49	X	X	CONTINENTAL CT 22
124.008	195/65 R 15 95 T Reinforced	6.5Jx15 H2 ET 49		X	UNIROYAL Rallye 340/65
	205/65 R 15 99 T Reinforced ³⁾	6.5Jx15 H2 ET 49		X	CONTINENTAL CT 22
124.019	195/65 R 15 91 H	6.5Jx15 H2 ET 44 6.5Jx15 H2 ET 48 6.5Jx15 H2 ET 49	X	X X X	CONTINENTAL Super Contact CH 90 DUNLOP SP Sport 200 GOODYEAR Eagle Touring NCT 3 MICHELIN MXV 3A PIRELLI P 6000 UNIROYAL Rallye 340/65
	205/60 R 15 91 H	7Jx15 H2 ET 41 7Jx15 H2 ET 42	X	X	CONTINENTAL Sport Contact CH 90 DUNLOP SP Sport 200 GOODYEAR Eagle Touring NCT 3 MICHELIN MXV 3A PIRELLI P 6000
124.020	185/65 R 15 88 H	6Jx15 H2 ET 49	X	X	CONTINENTAL Super Contact CH 90 MICHELIN MXV 3A PIRELLI P 2000 UNIROYAL Rallye 440
	205/60 R 15 91 H	7Jx15 H2 ET 41 7Jx15 H2 ET 42	X	X	CONTINENTAL Sport Contact CH 90 DUNLOP SP Sport 200 GOODYEAR Eagle Touring NCT 3 MICHELIN MXV 3A PIRELLI P 6000

1) Also permissible: 225/55 ZR 16 95 W or 225/55 R16 95W

3) Entry in vehicle documents required

Model	Tire designation	Disc wheel designation	Sheet-steel	Light-alloy	Recommended tire makes
with suspension for increased payload	195/65 R 15 91 H	6.5Jx15 H2 ET 44 6.5Jx15 H2 ET 48 6.5Jx15 H2 ET 49	X	X X X	CONTINENTAL Super Contact CH 90 DUNLOP SP Sport 200 GOODYEAR Eagle Touring NCT 3 MICHELIN MXV 3A PIRELLI P 6000 UNIROYAL Rallye 340/65
124.021	195/65 R 15 91 H	6.5Jx15 H2 ET 44 6.5Jx15 H2 ET 48 6.5Jx15 H2 ET 49	X	X X X	CONTINENTAL Super Contact CH 90 DUNLOP SP Sport 200 GOODYEAR Eagle Touring NCT 3 MICHELIN MXV 3A PIRELLI P 6000 UNIROYAL Rallye 340/65
	205/60 R 15 91 H	7Jx15 H2 ET 41 7Jx15 H2 ET 42	X	X	CONTINENTAL Sport Contact CH 90 DUNLOP SP Sport 200 GOODYEAR Eagle Touring NCT 3 MICHELIN MXV 3A PIRELLI P 6000
124.022	195/65 R 15 91 V	6.5Jx15 H2 ET 44 6.5Jx15 H2 ET 48 6.5Jx15 H2 ET 49	X	X X X	CONTINENTAL Super Contact CV 90 DUNLOP SP Sport 200 GOODYEAR Eagle Touring NCT 3 MICHELIN MXV 3A Pilot HX PIRELLI P 6000 UNIROYAL Rallye 340/65
	205/60 R 15 91 V	7Jx15 H2 ET 41 7Jx15 H2 ET 42	X	X	CONTINENTAL Sport Contact CV 90 DUNLOP SP Sport 200 GOODYEAR Eagle Touring NCT 3 MICHELIN MXM Pilot HX PIRELLI P 6000
124.023	195/65 R 15 91 H	6.5Jx15 H2 ET 44 6.5Jx15 H2 ET 48 6.5Jx15 H2 ET 49	X	X X X	CONTINENTAL Super Contact CH 90 DUNLOP SP Sport 200 GOODYEAR Eagle Touring NCT 3 MICHELIN MXV 3A PIRELLI P 6000 UNIROYAL Rallye 340/65

1) Also permissible: 225/55 ZR 16 95 W or 225/55 R16 95W

3) Entry in vehicle documents required

Model	Tire designation	Disc wheel designation	Sheet-steel	Light-alloy	Recommended tire makes
	205/60 R 15 91 H	7Jx15 H2 ET 41 7Jx15 H2 ET 42	X	X	CONTINENTAL Sport Contact CH 90 DUNLOP SP Sport 200 GOODYEAR Eagle Touring NCT 3 MICHELIN MXV 3A PIRELLI P 6000
124.026	195/65 R 15 91 V	6.5Jx15 H2 ET 44 6.5Jx15 H2 ET 48 6.5Jx15 H2 ET 49	X	X X X	CONTINENTAL Super Contact CV 90 DUNLOP SP Sport 200 GOODYEAR Eagle Touring NCT 3 MICHELIN MXV 3A Pilot HX PIRELLI P 6000 UNIROYAL Rallye 340/65
	205/60 R 15 91 V	7Jx15 H2 ET 41 7Jx15 H2 ET 42	X	X	CONTINENTAL Sport Contact CV 90 DUNLOP SP Sport 200 GOODYEAR Eagle Touring NCT 3 MICHELIN MXM Pilot HX PIRELLI P 6000
124.027	205/65 R 15 94 V	6.5Jx15 H2 ET 48 6.5Jx15 H2 ET 49	X	X X	DUNLOP SP Sport 200 MICHELIN MXV 3A Pilot HX PIRELLI P 6000 UNIROYAL Rallye 340/65
124.028	195/65 R 15 91 V	6.5Jx15 H2 ET 44 6.5Jx15 H2 ET 48 6.5Jx15 H2 ET 49	X	X X X	CONTINENTAL Super Contact CV 90 DUNLOP SP Sport 200 GOODYEAR Eagle Touring NCT 3 MICHELIN MXV 3A Pilot HX PIRELLI P 6000 UNIROYAL Rallye 340/65
	205/60 R 15 91 V	7Jx15 H2 ET 41 7Jx15 H2 ET 42	X	X	CONTINENTAL Sport Contact CV 90 DUNLOP SP Sport 200 GOODYEAR Eagle Touring NCT 3 MICHELIN MXM Pilot HX PIRELLI P 6000

1) Also permissible: 225/55 ZR 16 95 W or 225/55 R16 95W

3) Entry in vehicle documents required

Model	Tire designation	Disc wheel designation	Sheet-steel	Light-alloy	Recommended tire makes
124.029	205/65 R 15 94 V	6.5Jx15 H2 ET 48 6.5Jx15 H2 ET 49		X X	DUNLOP SP Sport 200 MICHELIN MXV 3A Pilot HX PIRELLI P 6000 UNIROYAL Rallye 340/65
124.030	195/65 R 15 91 V	6.5Jx15 H2 ET 44 6.5Jx15 H2 ET 48 6.5Jx15 H2 ET 49	X	X X X	CONTINENTAL Super Contact CV 90 DUNLOP SP Sport 200 GOODYEAR Eagle Touring NCT 3 MICHELIN MXV 3A Pilot HX PIRELLI P 6000 UNIROYAL Rallye 340/65
	205/60 R 15 91 V	7Jx15 H2 ET 41 7Jx15 H2 ET 42	X	X	CONTINENTAL Sport Contact CV 90 DUNLOP SP Sport 200 GOODYEAR Eagle Touring NCT 3 MICHELIN MXM Pilot HX PIRELLI P 6000
124.031/032	195/65 ZR 15	6.5Jx15 H2 ET 44 6.5Jx15 H2 ET 48 6.5Jx15 H2 ET 49		X X X	DUNLOP SP Sport D8 M2 GOODYEAR Eagle Touring NCT 3 MICHELIN MXV 3A Pilot HX
	205/60 ZR 15	7Jx15 H2 ET 41		X	GOODYEAR Eagle Touring NCT 3 MICHELIN MXV 3A Pilot HX
124.034 up to vehicle ident. end no. B-938 868	195/65 ZR 15	6.5Jx15 H2 ET 44 6.5Jx15 H2 ET 48 6.5Jx15 H2 ET 49		X X X	DUNLOP SP Sport D8 M2 GOODYEAR Eagle Touring NCT 3 MICHELIN MXV 3A Pilot HX
up to vehicle ident. end no. B-938 868	205/60 ZR 15	7Jx15 H2 ET 41		X	GOODYEAR Eagle Touring NCT 3 MICHELIN MXV 3A Pilot HX
as of vehicle ident. end no. B- 938869	215/55 ZR 16	7Jx16 H2 ET 46		X	MICHELIN MXV 3A Pilot HX PIRELLI P 4000 E
124.036	225/55 ZR 16 ¹⁾	8Jx16 H2 ET 34		X	DUNLOP SP Sport 2000 MICHELIN MXM Pilot HX

1) Also permissible: 225/55 ZR 16 95 W or 225/55 R16 95W

3) Entry in vehicle documents required

Model	Tire designation	Disc wheel designation	Sheet-steel	Light-alloy	Recommended tire makes
Limited special production	245/45 ZR 17	8,25Jx17 H2 ET 34		X	MICHELIN MXX Pilot SX
124.040/041	195/65 R 15 91 H	6.5Jx15 H2 ET 44 6.5Jx15 H2 ET 48 6.5Jx15 H2 ET 49	X	X X X	CONTINENTAL Super Contact CH 90 DUNLOP SP Sport 200 GOODYEAR Eagle Touring NCT 3 MICHELIN MXV 3A PIRELLI P 6000 UNIROYAL Rallye 340/65
	205/60 R 15 91 H	7Jx15 H2 ET 41 7Jx15 H2 ET 42	X	X	CONTINENTAL Sport Contact CH 90 DUNLOP SP Sport 200 GOODYEAR Eagle Touring NCT 3 MICHELIN MXV 3A PIRELLI P 6000
124.042	195/65 R 15 91 V	6.5Jx15 H2 ET 44 6.5Jx15 H2 ET 48 6.5Jx15 H2 ET 49	X	X X X	CONTINENTAL Super Contact CV 90 DUNLOP SP Sport 200 GOODYEAR Eagle Touring NCT 3 MICHELIN MXV 3A Pilot HX PIRELLI P 6000 UNIROYAL Rallye 340/65
	205/60 R 15 91 V	7Jx15 H2 ET 41 7Jx15 H2 ET 42	X	X	CONTINENTAL Sport Contact CV 90 DUNLOP SP Sport 200 GOODYEAR Eagle Touring NCT 3 MICHELIN MXM Pilot HX PIRELLI P 6000
124.043	195/65 R 15 91 H	6.5Jx15 H2 ET 44 6.5Jx15 H2 ET 48 6.5Jx15 H2 ET 49	X	X X X	CONTINENTAL Super Contact CH 90 DUNLOP SP Sport 200 GOODYEAR Eagle Touring NCT 3 MICHELIN MXV 3A PIRELLI P 6000 UNIROYAL Rallye 340/65

1) Also permissible: 225/55 ZR 16 95 W or 225/55 R16 95W

3) Entry in vehicle documents required

Model	Tire designation	Disc wheel designation	Sheet-steel	Light-alloy	Recommended tire makes
	205/60 R 15 91 H	7Jx15 H2 ET 41 7Jx15 H2 ET 42	X	X	CONTINENTAL Sport Contact CH 90 DUNLOP SP Sport 200 GOODYEAR Eagle Touring NCT 3 MICHELIN MXV 3A PIRELLI P 6000
124.050	195/65 R 15 91 V	6.5Jx15 H2 ET 44 6.5Jx15 H2 ET 48 6.5Jx15 H2 ET 49	X	X X X	CONTINENTAL Super Contact CV 90 DUNLOP SP Sport 200 GOODYEAR Eagle Touring NCT 3 MICHELIN MXV 3A Pilot HX PIRELLI P 6000 UNIROYAL Rallye 340/65
	205/60 R 15 91 V	7Jx15 H2 ET 41 7Jx15 H2 ET 42	X	X	CONTINENTAL Sport Contact CV 90 DUNLOP SP Sport 200 GOODYEAR Eagle Touring NCT 3 MICHELIN MXM Pilot HX PIRELLI P 6000
124.051/052	195/65 ZR 15	6.5Jx15 H2 ET 44 6.5Jx15 H2 ET 48 6.5Jx15 H2 ET 49		X X X	DUNLOP SP Sport D8 M2 GOODYEAR Eagle Touring NCT 3 MICHELIN MXV 3A Pilot HX
	205/60 ZR 15	7Jx15 H2 ET 41		X	GOODYEAR Eagle Touring NCT 3 MICHELIN MXV 3A Pilot HX
124.060	195/65 R 15 91 H	6.5Jx15 H2 ET 44 6.5Jx15 H2 ET 48 6.5Jx15 H2 ET 49	X	X X X	CONTINENTAL Super Contact CH 90 DUNLOP SP Sport 200 GOODYEAR Eagle Touring NCT 3 MICHELIN MXV 3A PIRELLI P 6000 UNIROYAL Rallye 340/65
	205/60 R 15 91 H	7Jx15 H2 ET 41 7Jx15 H2 ET 42	X	X	CONTINENTAL Sport Contact CH 90 DUNLOP SP Sport 200 GOODYEAR Eagle Touring NCT 3 MICHELIN MXV 3A PIRELLI P 6000

1) Also permissible: 225/55 ZR 16 95 W or 225/55 R16 95W

3) Entry in vehicle documents required

Model	Tire designation	Disc wheel designation	Sheet-steel	Light-alloy	Recommended tire makes
124.061	195/65 ZR 15	6.5Jx15 H2 ET 44 6.5Jx15 H2 ET 48 6.5Jx15 H2 ET 49		X X X	DUNLOP SP Sport D8 M2 GOODYEAR Eagle Touring NCT 3 MICHELIN MXV 3A Pilot HX
	205/60 ZR 15	7Jx15 H2 ET 41		X	GOODYEAR Eagle Touring NCT 3 MICHELIN MXV 3A Pilot HX
124.062	195/65 R 15 91 V	6.5Jx15 H2 ET 44 6.5Jx15 H2 ET 48 6.5Jx15 H2 ET 49	X	X X X	CONTINENTAL Super Contact CV 90 DUNLOP SP Sport 200 GOODYEAR Eagle Touring NCT 3 MICHELIN MXV 3A Pilot HX PIRELLI P 6000 UNIROYAL Rallye 340/65
	205/60 R 15 91 V	7Jx15 H2 ET 41 7Jx15 H2 ET 42	X	X	CONTINENTAL Sport Contact CV 90 DUNLOP SP Sport 200 GOODYEAR Eagle Touring NCT 3 MICHELIN MXM Pilot HX PIRELLI P 6000
124.066	195/65 ZR 15	6.5Jx15 H2 ET 44 6.5Jx15 H2 ET 48 6.5Jx15 H2 ET 49		X X X	DUNLOP SP Sport D8 M2 GOODYEAR Eagle Touring NCT 3 MICHELIN MXV 3A Pilot HX
	205/60 ZR 15	7Jx15 H2 ET 41		X	GOODYEAR Eagle Touring NCT 3 MICHELIN MXV 3A Pilot HX
124.079	195/65 R 15 91 H	6.5Jx15 H2 ET 44 6.5Jx15 H2 ET 48 6.5Jx15 H2 ET 49	X	X X X	CONTINENTAL Super Contact CH 90 DUNLOP SP Sport 200 GOODYEAR Eagle Touring NCT 3 MICHELIN MXV 3A PIRELLI P 6000 UNIROYAL Rallye 340/65
	205/60 R 15 91 H	7Jx15 H2 ET 41 7Jx15 H2 ET 42	X	X	CONTINENTAL Sport Contact CH 90 DUNLOP SP Sport 200 GOODYEAR Eagle Touring NCT 3 MICHELIN MXV 3A PIRELLI P 6000

1) Also permissible: 225/55 ZR 16 95 W or 225/55 R16 95W

3) Entry in vehicle documents required

Model	Tire designation	Disc wheel designation	Sheet-steel	Light-alloy	Recommended tire makes
124.080/081	195/65 R 15 91 T	6.5Jx15 H2 ET 44 6.5Jx15 H2 ET 48 6.5Jx15 H2 ET 49 6.5Jx15 H2 ET 49 Reinforced	X	X X X	DUNLOP SP 65 GOODYEAR GT 2 MICHELIN MXT MICHELIN MXT Energy PIRELLI P6000
	205/60 R 15 91 H	7Jx15 H2 ET 41 7Jx15 H2 ET 42	X	X	CONTINENTAL Sport Contact CH 90 DUNLOP SP Sport 200 GOODYEAR Eagle Touring NCT 3 MICHELIN MXV 3A PIRELLI P 6000
124.082/083	195/65 R 15 91 H	6.5Jx15 H2 ET 44 6.5Jx15 H2 ET 48 6.5Jx15 H2 ET 49	X	X X X	CONTINENTAL Super Contact CH 90 DUNLOP SP Sport 200 GOODYEAR Eagle Touring NCT 3 MICHELIN MXV 3A PIRELLI P 6000 UNIROYAL Rallye 340/65
	205/60 R 15 91 H	7Jx15 H2 ET 41 7Jx15 H2 ET 42	X	X	CONTINENTAL Sport Contact CH 90 DUNLOP SP Sport 200 GOODYEAR Eagle Touring NCT 3 MICHELIN MXV 3A PIRELLI P 6000
124.088	195/65 ZR 15	6.5Jx15 H2 ET 44 6.5Jx15 H2 ET 48 6.5Jx15 H2 ET 49		X X X	DUNLOP SP Sport D8 M2 GOODYEAR Eagle Touring NCT 3 MICHELIN MXV 3A Pilot HX
	205/60 ZR 15	7Jx15 H2 ET 41		X	GOODYEAR Eagle Touring NCT 3 MICHELIN MXV 3A Pilot HX
124.090	195/65 R 15 91 V	6.5Jx15 H2 ET 44 6.5Jx15 H2 ET 48 6.5Jx15 H2 ET 49	X	X X X	CONTINENTAL Super Contact CV 90 DUNLOP SP Sport 200 GOODYEAR Eagle Touring NCT 3 MICHELIN MXV 3A Pilot HX PIRELLI P 6000 UNIROYAL Rallye 340/65

1) Also permissible: 225/55 ZR 16 95 W or 225/55 R16 95W

3) Entry in vehicle documents required

Model	Tire designation	Disc wheel designation	Sheet-steel	Light-alloy	Recommended tire makes
	205/60 R 15 91 V	7Jx15 H2 ET 41 7Jx15 H2 ET 42	X	X	CONTINENTAL Sport Contact CV 90 DUNLOP SP Sport 200 GOODYEAR Eagle Touring NCT 3 MICHELIN MXM Pilot HX PIRELLI P 6000
124.091/092	195/65 ZR 15	6.5Jx15 H2 ET 44 6.5Jx15 H2 ET 48 6.5Jx15 H2 ET 49		X X X	DUNLOP SP Sport D8 M2 GOODYEAR Eagle Touring NCT 3 MICHELIN MXV 3A Pilot HX
	205/60 ZR 15	7Jx15 H2 ET 41		X	GOODYEAR Eagle Touring NCT 3 MICHELIN MXV 3A Pilot HX
124.104	195/65 R 15 95 T Reinforced	6.5Jx15 H2 ET 48 6.5Jx15 H2 ET 49	X	X	UNIROYAL Rallye 340/65
	205/65 R 15 99 T Reinforced ³⁾	6.5Jx15 H2 ET 48 6.5Jx15 H2 ET 49	X	X	CONTINENTAL CT 22
124.105 up to vehicle ident. end no. F-163557	195/65 R 15 91 T	6.5Jx15 H2 ET 44 6.5Jx15 H2 ET 48 6.5Jx15 H2 ET 49 6.5Jx15 H2 ET 49 Reinforced	X	X X X	DUNLOP SP 65 GOODYEAR GT 2 MICHELIN MXT MICHELIN MXT Energy PIRELLI P6000
as of vehicle ident. end no. F-163558	195/65 R 15 95 T Reinforced	6.5Jx15 H2 ET 48 6.5Jx15 H2 ET 49	X	X	UNIROYAL Rallye 340/65
as of vehicle ident. end no. F-163558	205/65 R 15 99 T Reinforced ³⁾	6.5Jx15 H2 ET 48 6.5Jx15 H2 ET 49	X	X	CONTINENTAL CT 22
124.106 up to vehicle ident. end no. F-161236	195/65 R 15 91 T	6.5Jx15 H2 ET 44 6.5Jx15 H2 ET 48 6.5Jx15 H2 ET 49 6.5Jx15 H2 ET 49 Reinforced	X	X X X	DUNLOP SP 65 GOODYEAR GT 2 MICHELIN MXT MICHELIN MXT Energy PIRELLI P6000

1) Also permissible: 225/55 ZR 16 95 W or 225/55 R16 95W

3) Entry in vehicle documents required

Model	Tire designation	Disc wheel designation	Sheet-steel	Light-alloy	Recommended tire makes
as of vehicle ident. end no. F-161237	195/65 R 15 95 T Reinforced	6.5Jx15 H2 ET 48 6.5Jx15 H2 ET 49	X	X	UNIROYAL Rallye 340/65
as of vehicle ident. end no. F-161237	205/65 R 15 99 T Reinforced ³⁾	6.5Jx15 H2 ET 48 6.5Jx15 H2 ET 49	X	X	CONTINENTAL CT 22
124.107	195/65 R 15 95 T Reinforced	6.5Jx15 H2 ET 48 6.5Jx15 H2 ET 49	X	X	UNIROYAL Rallye 340/65
	205/65 R 15 99 T Reinforced ³⁾	6.5Jx15 H2 ET 48 6.5Jx15 H2 ET 49	X	X	CONTINENTAL CT 22
124.12	205/60 R 15 91 H	7Jx15 H2 ET 41 7Jx15 H2 ET 42	X	X	CONTINENTAL Sport Contact CH 90 DUNLOP SP Sport 200 GOODYEAR Eagle Touring NCT 3 MICHELIN MXV 3A PIRELLI P 6000
124.120	185/65 R 15 88 T	6Jx15 H2 ET 49	X	X	CONTINENTAL Contact CT22 DUNLOP SP9* GOODYEAR GT 2 MICHELIN MXT MICHELIN MXT Energy PIRELLI P2000
with spring for increased payload	195/65 R 15 91 T	6.5Jx15 H2 ET 44 6.5Jx15 H2 ET 48 6.5Jx15 H2 ET 49	X	X X X	DUNLOP SP65 GOODYEAR GT 2 MICHELIN MXT MICHELIN MXT Energy PIRELLI P6000
with 8-hole 6 ½ Jx15 H2 ET 44 light-alloy disc wheel	195/65 R 15 91 T	6.5Jx15 H2 ET 44		X	DUNLOP SP 65 GOODYEAR GT 2 MICHELIN MXT MICHELIN MXT Energy PIRELLI P6000

1) Also permissible: 225/55 ZR 16 95 W or 225/55 R16 95W

3) Entry in vehicle documents required

Model	Tire designation	Disc wheel designation	Sheet-steel	Light-alloy	Recommended tire makes
124.125	195/65 R 15 91 T	6.5Jx15 H2 ET 44 6.5Jx15 H2 ET 48 6.5Jx15 H2 ET 49 6.5Jx15 H2 ET 49 Reinforced	X	X X X	DUNLOP SP 65 GOODYEAR GT 2 MICHELIN MXT MICHELIN MXT Energy PIRELLI P6000
124.126	195/65 R 15 91 H	6.5Jx15 H2 ET 44 6.5Jx15 H2 ET 48 6.5Jx15 H2 ET 49	X	X X X	CONTINENTAL Super Contact CH 90 DUNLOP SP Sport 200 GOODYEAR Eagle Touring NCT 3 MICHELIN MXV 3A PIRELLI P 6000 UNIROYAL Rallye 340/65
124.127	205/65 R 15 94 H	6.5Jx15 H2 ET 48 6.5Jx15 H2 ET 49	X	X X	CONTINENTAL Eco Contact CP DUNLOP SP Sport 200 GOODYEAR Eagle Touring NCT 3 MICHELIN MXV 3A Energy PIRELLI P 6000 UNIROYAL Rallye 340/65
124.128	195/65 R 15 91 H	6.5Jx15 H2 ET 44 6.5Jx15 H2 ET 48 6.5Jx15 H2 ET 49	X	X X X	CONTINENTAL Super Contact CH 90 DUNLOP SP Sport 200 GOODYEAR Eagle Touring NCT 3 MICHELIN MXV 3A PIRELLI P 6000 UNIROYAL Rallye 340/65
124.129	205/65 R 15 94 H	6.5Jx15 H2 ET 48 6.5Jx15 H2 ET 49	X	X X	CONTINENTAL Eco Contact CP DUNLOP SP Sport 200 GOODYEAR Eagle Touring NCT 3 MICHELIN MXV 3A Energy PIRELLI P 6000 UNIROYAL Rallye 340/65
124.13	205/60 R 15 91 H	7Jx15 H2 ET 41 7Jx15 H2 ET 42	X	X	CONTINENTAL Sport Contact CH 90 DUNLOP SP Sport 200 GOODYEAR Eagle Touring NCT 3 MICHELIN MXV 3A PIRELLI P 6000

1) Also permissible: 225/55 ZR 16 95 W or 225/55 R16 95W

3) Entry in vehicle documents required

Model	Tire designation	Disc wheel designation	Sheet-steel	Light-alloy	Recommended tire makes
124.130/131 /133	195/65 R 15 91 H	6.5Jx15 H2 ET 44 6.5Jx15 H2 ET 48 6.5Jx15 H2 ET 49	X	X X X	CONTINENTAL Super Contact CH 90 DUNLOP SP Sport 200 GOODYEAR Eagle Touring NCT 3 MICHELIN MXV 3A PIRELLI P 6000 UNIROYAL Rallye 340/65
124.18	205/60 R 15 91 H	7Jx15 H2 ET 41 7Jx15 H2 ET 42	X	X	CONTINENTAL Sport Contact CH 90 DUNLOP SP Sport 200 GOODYEAR Eagle Touring NCT 3 MICHELIN MXV 3A PIRELLI P 6000
124.180/185 /186	195/65 R 15 91 T	6.5Jx15 H2 ET 44 6.5Jx15 H2 ET 48 6.5Jx15 H2 ET 49 6.5Jx15 H2 ET 49 Reinforced	X	X X X	DUNLOP SP 65 GOODYEAR GT 2 MICHELIN MXT MICHELIN MXT Energy PIRELLI P6000
124.188	195/65 R 15 91 H	6.5Jx15 H2 ET 44 6.5Jx15 H2 ET 48 6.5Jx15 H2 ET 49	X	X X X	CONTINENTAL Super Contact CH 90 DUNLOP SP Sport 200 GOODYEAR Eagle Touring NCT 3 MICHELIN MXV 3A PIRELLI P 6000 UNIROYAL Rallye 340/65
124.19	205/60 R 15 91 H	7Jx15 H2 ET 41 7Jx15 H2 ET 42	X	X	CONTINENTAL Sport Contact CH 90 DUNLOP SP Sport 200 GOODYEAR Eagle Touring NCT 3 MICHELIN MXV 3A PIRELLI P 6000
124.190	195/65 R 15 91 T	6.5Jx15 H2 ET 44 6.5Jx15 H2 ET 48 6.5Jx15 H2 ET 49 6.5Jx15 H2 ET 49 Reinforced	X	X X X	DUNLOP SP 65 GOODYEAR GT 2 MICHELIN MXT MICHELIN MXT Energy PIRELLI P6000

1) Also permissible: 225/55 ZR 16 95 W or 225/55 R16 95W

3) Entry in vehicle documents required

Model	Tire designation	Disc wheel designation	Sheet-steel	Light-alloy	Recommended tire makes
124.191/193	195/65 R 15 91 H	6.5Jx15 H2 ET 44 6.5Jx15 H2 ET 48 6.5Jx15 H2 ET 49	X	X X X	CONTINENTAL Super Contact CH 90 DUNLOP SP Sport 200 GOODYEAR Eagle Touring NCT 3 MICHELIN MXV 3A PIRELLI P 6000 UNIROYAL Rallye 340/65
124.226/230 /290	195/65 R 15 91 V	6.5Jx15 H2 ET 44 6.5Jx15 H2 ET 48 6.5Jx15 H2 ET 49	X	X X X	CONTINENTAL Super Contact CV 90 DUNLOP SP Sport 200 GOODYEAR Eagle Touring NCT 3 MICHELIN MXV 3A Pilot HX PIRELLI P 6000 UNIROYAL Rallye 340/65
124.330	195/65 R 15 91 T	6.5Jx15 H2 ET 44 6.5Jx15 H2 ET 48 6.5Jx15 H2 ET 49 6.5Jx15 H2 ET 49 Reinforced	X	X X X	DUNLOP SP 65 GOODYEAR GT 2 MICHELIN MXT MICHELIN MXT Energy PIRELLI P6000
124.333/393	195/65 R 15 91 H	6.5Jx15 H2 ET 44 6.5Jx15 H2 ET 48 6.5Jx15 H2 ET 49	X	X X X	CONTINENTAL Super Contact CH 90 DUNLOP SP Sport 200 GOODYEAR Eagle Touring NCT 3 MICHELIN MXV 3A PIRELLI P 6000 UNIROYAL Rallye 340/65

1) Also permissible: 225/55 ZR 16 95 W or 225/55 R16 95W

3) Entry in vehicle documents required

K6	GF40.10-P-1050-02AM	Survey of summer tires/disk wheels/recommended tire makes	Model 124 with code 990 AMG vehicles	 GF
-----------	---------------------	---	--------------------------------------	---

Model	Tire designation	Disc wheel designation	Sheet-steel	Light-alloy	Recommended tire makes
AMG 124 except 124.034/036/ 06/07/08/18/ 19	205/55 ZR 16	7,5Jx16 H2 ET 31 7,5Jx16 H2 ET 37 7,5Jx16 H2 ET 40		X X X	CONTINENTAL CZ 91 NO DUNLOP D 40 MICHELIN MXX PIRELLI P 700-Z N1 BRIDGESTONE RE 71 N EXPEDIA S-01
AMG 124 except 124.034/036	FA: 205/55 ZR 16 RA: 225/50 ZR 16	7,5Jx16 H2 ET 31 7,5Jx16 H2 ET 37 7,5Jx16 H2 ET 40		X X X	CONTINENTAL CZ 91 NO DUNLOP D 40 GOODYEAR Eagle NCT 2 MICHELIN MXX PIRELLI P 700-Z N1 BRIDGESTONE RE 71 N EXPEDIA S-01
AMG 124 except 124.036	225/45 ZR 17	7,5Jx17 H2 ET 42		X	DUNLOP SP Sport 8000 MFS MICHELIN MXX 3 Pilot SX EXPEDIA S-01 (225/45 ZR 17 93W)
	235/45 ZR 17	8Jx17 H2 ET 28 8,5Jx17 H2 ET 30		X	DUNLOP SP Sport 8000 MFS DUNLOP D 40 MICHELIN MXX 3 Pilot SX EXPEDIA S-01
AMG 124.019/020 /021	205/60 R 15 91 H	7Jx15 H2 ET 25 7Jx15 H2 ET 35		X	CONTINENTAL Super Contact CH 90 DUNLOP SP Sport 200 GOODYEAR Eagle Touring NCT 3 MICHELIN MXV 3A PIRELLI P 4000E

14) Not in conjunction with code 957

Model	Tire designation	Disc wheel designation	Sheet-steel	Light-alloy	Recommended tire makes
AMG ¹⁴⁾ 124.022	205/60 ZR 15	7Jx15 H2 ET 25 7Jx15 H2 ET 35		X	GOODYEAR Eagle Touring NCT 3 MICHELIN MXV 3A Pilot HX
AMG 124.023	205/60 R 15 91 H	7Jx15 H2 ET 25 7Jx15 H2 ET 35		X	CONTINENTAL Super Contact CH 90 DUNLOP SP Sport 200 GOODYEAR Eagle Touring NCT 3 MICHELIN MXV 3A PIRELLI P 4000E
AMG ¹⁴⁾ 124.026/028 /030/031 /032	205/60 ZR 15	7Jx15 H2 ET 25 7Jx15 H2 ET 35		X	GOODYEAR Eagle Touring NCT 3 MICHELIN MXV 3A Pilot HX
AMG 124.036	245/45 ZR 17	8,5Jx17 H2 ET 30		X	DUNLOP SP Sport 8000 MFS DUNLOP D 40 M2 MICHELIN MXX 3 Pilot SX EXPEDIA S-01
AMG 124.040/041	205/60 R 15 91 H	7Jx15 H2 ET 25 7Jx15 H2 ET 35		X	CONTINENTAL Super Contact CH 90 DUNLOP SP Sport 200 GOODYEAR Eagle Touring NCT 3 MICHELIN MXV 3A PIRELLI P 4000E
AMG ¹⁴⁾ 124.042	205/60 ZR 15	7Jx15 H2 ET 25 7Jx15 H2 ET 35		X	GOODYEAR Eagle Touring NCT 3 MICHELIN MXV 3A Pilot HX
AMG 124.043	205/60 R 15 91 H	7Jx15 H2 ET 25 7Jx15 H2 ET 35		X	CONTINENTAL Super Contact CH 90 DUNLOP SP Sport 200 GOODYEAR Eagle Touring NCT 3 MICHELIN MXV 3A PIRELLI P 4000E
AMG ¹⁴⁾ 124.050	205/60 ZR 15	7Jx15 H2 ET 25 7Jx15 H2 ET 35		X	GOODYEAR Eagle Touring NCT 3 MICHELIN MXV 3A Pilot HX

14) Not in conjunction with code 957

Model	Tire designation	Disc wheel designation	Sheet-steel	Light-alloy	Recommended tire makes
AMG ¹⁴⁾ 124.051/052	205/60 ZR 15	7Jx15 H2 ET 25		X	GOODYEAR Eagle Touring NCT 3 MICHELIN MXV 3A Pilot HX
AMG 124.060	205/60 R 15 91 H	7Jx15 H2 ET 25 7Jx15 H2 ET 35		X	CONTINENTAL Super Contact CH 90 DUNLOP SP Sport 200 GOODYEAR Eagle Touring NCT 3 MICHELIN MXV 3A PIRELLI P 4000E
AMG ¹⁴⁾ 124.061/062 /066	205/60 ZR 15	7Jx15 H2 ET 25		X	GOODYEAR Eagle Touring NCT 3 MICHELIN MXV 3A Pilot HX
AMG 124.079/080 /081/082 /083	205/60 R 15 91 H	7Jx15 H2 ET 25 7Jx15 H2 ET 35		X	CONTINENTAL Super Contact CH 90 DUNLOP SP Sport 200 GOODYEAR Eagle Touring NCT 3 MICHELIN MXV 3A PIRELLI P 4000E
AMG ¹⁴⁾ 124.088/090	205/60 ZR 15	7Jx15 H2 ET 25 7Jx15 H2 ET 35		X	GOODYEAR Eagle Touring NCT 3 MICHELIN MXV 3A Pilot HX
AMG ¹⁴⁾ 124.091/092	205/60 ZR 15	7Jx15 H2 ET 25		X	GOODYEAR Eagle Touring NCT 3 MICHELIN MXV 3A Pilot HX
AMG 124.12/13/18/ /19	205/60 R 15 91 H	7Jx15 H2 ET 25 7Jx15 H2 ET 35		X	CONTINENTAL Super Contact CH 90 DUNLOP SP Sport 200 GOODYEAR Eagle Touring NCT 3 MICHELIN MXV 3A PIRELLI P 4000E

14) Not in conjunction with code 957

N6	GF40.10-P-1050-02B	Survey of summer tires/disc wheels/recommended tire makes	Model 129	 GF
-----------	--------------------	---	-----------	---

Type	Tire designation	Disc wheel designation	Sheet-steel	Light-alloy	Recommended tire makes
129.058/063 /067/076 up to MY 98 (up to code 808)	225/55 ZR 16	8Jx16 H2 ET 34		X	DUNLOP SP Sport 2000 MICHELIN MXM Pilot HX ¹⁾ PIRELLI P 6000 ¹⁾
up to MY 98 (up to code 808)	FA: 235/45 R 17 94W RA: 245/45 R 17 95W	8.25Jx17 H2 ET 34		X	CONTINENTAL Conti Sport Contact
up to MY 98 (up to code 808)	245/45 R 17 95 W	8.25Jx17 H2 ET 34		X	CONTINENTAL Conti Sport Contact MICHELIN MXX 3 Pilot SX DUNLOP Sport 9000 MFS
129.059/064 /068/076 as of MY 99 (as of code 809)	245/45 R 17 95 W	8.25Jx17 H2 ET 34		X	CONTINENTAL Conti Sport Contact MICHELIN MXX 3 Pilot SX DUNLOP Sport 9000 MFS
129 special series Mille Miglia	245/45 ZR 17 ^{15.)}	8.25Jx17 H2 ET 34		X	MICHELIN MXX 3 Pilot SX
129.059/064 068/076 special series Special Edition	245/40 ZR 18	8Jx18 H2 ET 31		X	MICHELIN Pilot Sport DUNLOP Sport 9000 MFS
	245/45 R 17 95 W	8.25Jx17 H2 ET 34		X	CONTINENTAL Conti Sport Contact MICHELIN MXX 3 Pilot SX DUNLOP Sport 9000 MFS

1) Also permissible: 225/55 R16 95W

15.) Conversion only in conjunction with steering gear (limited steering lock)

16.) Observe country specific-legislation

20) Tires with dimensions 245/45 R 17 95W

06	GF40.10-P-1050-02BM	Survey of summer tires/disk wheels/recommended tire makes	Model 129 with code 990 AMG vehicles	 GF
-----------	---------------------	---	--------------------------------------	---

Type	Tire designation	Disc wheel designation	Sheet-steel	Light-alloy	Recommended tire makes
129 up to MY 98 (up to code 808)	FA: 235/45 ZR 17 RA: 255/40 ZR 17	FA: 8,5Jx17 ET 18 RA: 10Jx17 ET 17		X	BRIDGESTONE Expedia S-01
up to MY 98 (up to code 808)	245/40 ZR 18	8Jx18 ET 31		X	DUNLOP SP Sport 8000 MFS DUNLOP SP Sport 9000 MFS 1) MICHELIN Pilot Sport CONTINENTAL Conti Sport Contact
up to MY 98 (up to code 808)	245/40 ZR 18	8,5Jx18 H2 ET 25		X	DUNLOP SP Sport 8000 MFS DUNLOP SP Sport 9000 MFS 1) MICHELIN Pilot Sport CONTINENTAL Conti Sport Contact
up to MY 98 (up to code 808)	FA: 245/40 ZR 18 RA: 275/35 ZR 18	FA: 8Jx18 ET 31 RA: 9Jx18 ET 35		X	DUNLOP SP Sport 8000 MFS DUNLOP SP Sport 9000 MFS 1) MICHELIN Pilot Sport 1) CONTINENTAL Conti Sport Contact 1)
up to MY 98 (up to code 808)	245/45 ZR 17	8,5Jx17 ET 18		X	DUNLOP SP Sport 8000 MFS MICHELIN MXX 3 Pilot SX BRIDGESTONE EXPEDIA S-01
up to MY 98 (up to code 808)	FA: 235/45 ZR 17 RA: 265/40 ZR 17	FA: 8,5Jx17 ET 18 RA: 10Jx17 ET 17		X	DUNLOP SP Sport 8000 MFS MICHELIN MXX 3 Pilot SX BRIDGESTONE Expedia S-01
	FA: 245/40 ZR 18 RA: 275/35 ZR 18	FA: 8,5Jx18 H2 ET 25 RA: 9,5Jx18 H2 ET 23		X	DUNLOP SP Sport 8000 MFS DUNLOP SP Sport 9000 MFS 1) MICHELIN Pilot Sport 1) CONTINENTAL Conti Sport Contact 1)

1) Tire approval being prepared



Type	Tire designation	Disc wheel designation	Sheet-steel	Light-alloy	Recommended tire makes
	FA: 245/40 ZR 18 RA: 275/35 ZR 18	FA: 8,5Jx18 H2 ET 25 RA: 10Jx18 H2 ET 25		X	DUNLOP SP Sport 8000 MFS DUNLOP SP Sport 9000 MFS 1) MICHELIN Pilot Sport 1) CONTINENTAL Conti Sport Contact 1)

1) Tire approval being prepared

A7	GF40.10-P-1050-02C	Survey of summer tires/disc wheels/recommended tire makes	Model 140	
-----------	--------------------	---	-----------	---

Model	Tire designation	Disc wheel designation	Sheet-steel	Light-alloy	Recommended tire makes
140.028	235/60 R 16 100 V	7,5Jx16 H2 ET 51	X	X	CONTINENTAL Sport Contact CV90 DUNLOP SP Sport 2000 PIRELLI P 6000 MICHELIN MXM Pilot HX
	255/45 ZR 18	8,5Jx18 H2 ET 47		X	CONTINENTAL Sport Contact MICHELIN MXX 3 Pilot SX
140.032/033	255/45 ZR 18	8,5Jx18 H2 ET 47		X	CONTINENTAL Sport Contact MICHELIN MXX 3 Pilot SX
Up to vehicle ident. end no. A-120 931	225/60 R 16 97 V	7,5Jx16 H2 ET 51	X	X	GOODYEAR Eagle NTC 2
Up to vehicle ident. end no. A-120 931	225/60 R 16 98 V	7,5Jx16 H2 ET 51	X	X	DUNLOP SP Sport 2020 E GOODYEAR Eagle NTC 3 ²⁾ MICHELIN MXM Pilot HX ³⁾ CONTINENTAL Eco Contact CP ³⁾
As of vehicle ident. end no. A120 932	235/60 R 16 100 H	7,5Jx16 H2 ET 51	X	X	DUNLOP SP Sport 2000 PIRELLI P 6000
As of vehicle ident. end no. A120 932	235/60 R 16 100 V	7,5Jx16 H2 ET 51	X	X	CONTINENTAL Sport Contact CV90 DUNLOP SP Sport 2000 PIRELLI P 6000 MICHELIN MXM Pilot HX

1) Also permissible: 235/60 ZR 16 100 W or 235/60 R16 100W

2) Also permissible: 225/60 ZR 16 98W or 225/60 R16 98W

3) Also permissible: 225/60 R 16 98W

17) The following restriction applies in the event of a tire failure: Max. distance 20 km, max. 80 km/h.

The following restrictions due to higher axle loads apply to the Pullmann: Maximum speed 160 km/h, maximum kilometerage 10,000 km, effective period of use max. 1 year. When the tread depth is 3 mm, the tire is to be replaced.

Model	Tire designation	Disc wheel designation	Sheet-steel	Light-alloy	Recommended tire makes
140.04	235/60 ZR 16 ¹⁾	7,5Jx16 H2 ET 51		X	CONTINENTAL Sport Contact CZ 90 DUNLOP SP Sport 2000 MICHELIN MXM Pilot HX PIRELLI P 6000
140.042/043	235/60 ZR 16 ¹⁾	7,5Jx16 H2 ET 51		X	CONTINENTAL Sport Contact CZ 90 DUNLOP SP Sport 2000 MICHELIN MXM Pilot HX PIRELLI P 6000
	255/45 ZR 18	8,5Jx18 H2 ET 47		X	CONTINENTAL Sport Contact MICHELIN MXX 3 Pilot SX
140.050/051	235/60 ZR 16 ¹⁾	7,5Jx16 H2 ET 51		X	CONTINENTAL Sport Contact CZ 90 DUNLOP SP Sport 2000 MICHELIN MXM Pilot HX PIRELLI P 6000
	255/45 ZR 18	8,5Jx18 H2 ET 47		X	CONTINENTAL Sport Contact MICHELIN MXX 3 Pilot SX
140.056/057	235/60 ZR 16 ¹⁾	7,5Jx16 H2 ET 51		X	CONTINENTAL Sport Contact CZ 90 DUNLOP SP Sport 2000 MICHELIN MXM Pilot HX PIRELLI P 6000
	255/45 ZR 18	8,5Jx18 H2 ET 47		X	CONTINENTAL Sport Contact MICHELIN MXX 3 Pilot SX
140.051/057 ¹⁷⁾ Special protection	CT265/40 R 500 114 H /118 Q Reinforced	CT 500x180A ET 55		X	CONTINENTAL CH 81

1) Also permissible: 235/60 ZR 16 100 W or 235/60 R16 100W

2) Also permissible: 225/60 ZR 16 98W or 225/60 R16 98W

3) Also permissible: 225/60 R 16 98W

17) The following restriction applies in the event of a tire failure: Max. distance 20 km, max. 80 km/h.

The following restrictions due to higher axle loads apply to the Pullmann: Maximum speed 160 km/h, maximum kilometerage 10,000 km, effective period of use max. 1 year. When the tread depth is 3 mm, the tire is to be replaced.

Model	Tire designation	Disc wheel designation	Sheet-steel	Light-alloy	Recommended tire makes
140.051/057 Pullmann (not armored)	255/45 ZR 18	8,5Jx18 H2 ET 47		X	CONTINENTAL Sport Contact
140.063	235/60 ZR 16 ¹⁾	7,5Jx16 H2 ET 51		X	CONTINENTAL Sport Contact CZ 90 DUNLOP SP Sport 2000 MICHELIN MXM Pilot HX PIRELLI P 6000
as of 03/94	255/45 ZR 18	8,5Jx18 H2 ET 47		X	CONTINENTAL Sport Contact MICHELIN MXX 3 Pilot SX
140.070/076 up to 02/94	235/60 ZR 16 ¹⁾	7,5Jx16 H2 ET 51		X	CONTINENTAL Sport Contact CZ 90 DUNLOP SP Sport 2000 MICHELIN MXM Pilot HX PIRELLI P 6000
as of 03/94	255/45 ZR 18	8,5Jx18 H2 ET 47		X	CONTINENTAL Sport Contact MICHELIN MXX 3 Pilot SX
140.134	235/60 R 16 100 H	7,5Jx16 H2 ET 51	X	X	DUNLOP SP Sport 2000 PIRELLI P 6000
140.135	235/60 R 16 100 H	7,5Jx16 H2 ET 51	X	X	DUNLOP SP Sport 2000 PIRELLI P 6000
	235/60 R 16 100 V	7,5Jx16 H2 ET 51	X	X	CONTINENTAL Sport Contact CV 90 DUNLOP SP Sport 2000 MICHELIN MXM Pilot HX PIRELLI P 6000
	255/45 ZR 18	8,5Jx18 H2 ET 47		X	CONTINENTAL Sport Contact MICHELIN MXX 3 Pilot SX

1) Also permissible: 235/60 ZR 16 100 W or 235/60 R16 100W

2) Also permissible: 225/60 ZR 16 98W or 225/60 R16 98W

3) Also permissible: 225/60 R 16 98W

17) The following restriction applies in the event of a tire failure: Max. distance 20 km, max. 80 km/h.

The following restrictions due to higher axle loads apply to the Pullmann: Maximum speed 160 km/h, maximum kilometerage 10,000 km, effective period of use max. 1 year. When the tread depth is 3 mm, the tire is to be replaced.

D7	GF40.10-P-1050-02CM	Survey of summer tires/disk wheels/recommended tire makes	Model 140 with code 990 AMG vehicles	 GF
-----------	---------------------	---	--------------------------------------	---

Model	Tire designation	Disc wheel designation	Sheet-steel	Light-alloy	Recommended tire makes
AMG 140	255/45 ZR 18	8,5Jx18 H2 ET 44		X	CONTINENTAL Conti Sport Contact MICHELIN MXX 3 Pilot SX BRIDGESTONE EXPEDIA S-01
	255/45 ZR 18	8,5Jx18 H2 ET 47		X	CONTINENTAL Conti Sport Contact MICHELIN MXX 3 Pilot SX BRIDGESTONE EXPEDIA S-01
	255/40 ZR 19	8,5Jx19 H2 ET 46		X	DUNLOP SP Sport 8000 MFS
	VA: 255/40 ZR 19 HA: 285/35 ZR 19	VA: 8,5Jx19 H2 ET 46 HA: 9,5Jx19 H2 ET 46		X	DUNLOP SP Sport 8000 MFS



E7	GF40.10-P-1050-02GH Survey of summer tires/disk wheels/recommended tire makes		 GF
-----------	--	--	---

Model	Tire designation	Disc wheel designation	Sheet-steel	Light-alloy	Recommended tire makes
163.136/154	225/75 R16 104H ¹⁰⁾	6,5Jx16 H2 ET 47		X	CONTINENTAL General Tire Grabber ST DUNLOP Grand Trek
	255/65 R16 109H ¹⁰⁾	8Jx16 H2 ET 62		X	CONTINENTAL General Tire Grabber ST DUNLOP Grand Trek
	275/55 R17 109H ¹⁰⁾	8,5Jx17 H2 ET 52		X	CONTINENTAL General Tire DUNLOP Grand Trek

¹⁰⁾ Tires have M&S,

F7 GF40.10-P-1050-02GC	Survey of summer tires/disk wheels/recommended tire makes	Model 168	 GF
---------------------------	---	-----------	--

Model	Tire designation	Disc wheel designation	Sheet-steel	Light-alloy	Recommended tire makes
168.007 FRG only	155/70 R 15 78 T	5 J x 15 H2 ET44	X	X	MICHELIN Energy XT 1 GOODYEAR GT2-E
168.007 except FRG	195/50 R 15 82 H	5.5 J x 15 H2 ET54	X	X	GOODYEAR Eagle Touring NCT-3
	195/50 R 15 82 T	5.5 J x 15 H2 ET54	X	X	CONTINENTAL Eco Contact CP ¹⁾ DUNLOP SP10 3 E GOODYEAR GT2-E MICHELIN XT 2 PIRELLI P6000
	195/50 R 15 82 V	5.5 J x 15 H2 ET54	X	X	CONTINENTAL Eco Contact CP ¹⁾ DUNLOP SP Sport 2020 MICHELIN MXV 3A Pilot HX PIRELLI P6000
	205/45 R 16 83H MO	6.5 J x 16 H2 ET54		X	DUNLOP SP Sport 2000E
168.008/031	195/50 R 15 82 H	5.5 J x 15 H2 ET54	X	X	GOODYEAR Eagle Touring NCT-3
	195/50 R 15 82 T	5.5 J x 15 H2 ET54	X	X	CONTINENTAL Eco Contact CP ¹⁾ DUNLOP SP10 3 E GOODYEAR GT2-E MICHELIN XT 2 PIRELLI P6000
	195/50 R 15 82 V	5.5 J x 15 H2 ET54	X	X	CONTINENTAL Eco Contact CP ¹⁾ DUNLOP SP Sport 2020 MICHELIN MXV 3A Pilot HX PIRELLI P6000

1) Not permissible for vehicles with sports suspension

Model	Tire designation	Disc wheel designation	Sheet-steel	Light-alloy	Recommended tire makes
	205/45 R 16 83H MO	6.5 J x 16 H2 ET54		X	DUNLOP SP Sport 2000E
168.032	195/50 R 16 84 H MO	5.5 J x 16 H2 ET54		X	CONTINENTAL Sport Contact GOODYEAR Eagle Touring NCT-3 PIRELLI P6000
	205/45 R 16 83H MO	6.5 J x 16 H2 ET54		X	DUNLOP SP Sport 2000E
168.033	195/50 R 15 82 H	5.5 J x 15 H2 ET54	X	X	GOODYEAR Eagle Touring NCT-3
	195/50 R 15 82 T	5.5 J x 15 H2 ET54	X	X	CONTINENTAL Eco Contact CP ¹⁾ DUNLOP SP10 3 E GOODYEAR GT2-E MICHELIN XT 2 PIRELLI P6000
	195/50 R 15 82 V	5.5 J x 15 H2 ET54	X	X	CONTINENTAL Eco Contact CP ¹⁾ DUNLOP SP Sport 2020 MICHELIN MXV 3A Pilot HX PIRELLI P6000
	205/45 R 16 83H MO	6.5 J x 16 H2 ET54		X	DUNLOP SP Sport 2000E

1) Not permissible for vehicles with sports suspension

H7	GF40.10-P-1050-02K	Survey of summer tires/disk wheels/recommended tire makes	Model 170	 GF
-----------	--------------------	---	-----------	---

Model	Tire designation	Disc wheel designation	Sheet-steel	Light-alloy	Recommended tire makes
170.435	205/60 R 15 91 H	7Jx15 H2 ET 37		X	DUNLOP SP Sport 200 PIRELLI P 6000 MICHELIN MXM Pilot HX
	205/60 R 15 91 V	7Jx15 H2 ET 37		X	DUNLOP SP Sport 200 MICHELIN MXM Pilot HX PIRELLI P 6000
	205/55 R 16 91 H	7Jx16 H2 ET 37		X	CONTINENTAL Conti Sport Contact
	205/55 R 16 91 V	7Jx16 H2 ET 37		X	CONTINENTAL Conti Sport Contact DUNLOP SP Sport 2000 E MICHELIN MXM G1 Pilot HX PIRELLI P 6000
	FA 205/55 R 16 91 V RA 225/50 R 16 92 V ⁶⁾	FA 7Jx16 H2 ET 37 RA 8Jx16 H2 ET 30		X	CONTINENTAL Conti Sport Contact DUNLOP SP Sport 2000 E FA MICHELIN G1 MXM Pilot HX RA MICHELIN MXM Pilot HX PIRELLI P 6000
	FA 205/55 R 16 91 W RA 225/50 R 16 92 W ⁶⁾	FA 7Jx16 H2 ET 37 RA 8Jx16 H2 ET 30		X	CONTINENTAL Conti Sport Contact FA MICHELIN G1 MXM Pilot HX RA MICHELIN MXM Pilot HX PIRELLI P 6000
170.445/447	205/55 R 16 91 V	7Jx16 H2 ET 37		X	CONTINENTAL Conti Sport Contact DUNLOP SP Sport 2000 E MICHELIN MXM G1 Pilot HX PIRELLI P 6000
	205/55 R 16 91 W	7Jx16 H2 ET 37		X	CONTINENTAL Conti Sport Contact

6) Cover for wide base tires required for retrofitting



Model	Tire designation	Disc wheel designation	Sheet-steel	Light-alloy	Recommended tire makes
	FA 205/55 R 16 91 V RA 225/50 R 16 92 V ⁶⁾	FA 7Jx16 H2 ET 37 RA 8Jx16 H2 ET 30		X	CONTINENTAL Conti Sport Contact DUNLOP SP Sport 2000 E FA MICHELIN G1 MXM Pilot HX RA MICHELIN MXM Pilot HX PIRELLI P 6000
	FA 205/55 R 16 91 W RA 225/50 R 16 92 W ⁶⁾	FA 7Jx16 H2 ET 37 RA 8Jx16 H2 ET 30		X	CONTINENTAL Conti Sport Contact FA MICHELIN G1 MXM Pilot HX RA MICHELIN MXM Pilot HX PIRELLI P 6000

6) Cover for wide base tires required for retrofitting

Spare wheel

Model	Tire designation	Disc wheel designation	Sheet-steel	Light-alloy	Recommended tire makes
170.435/445/ 447	Inflatable spare tires	4.5Jx 15 ET 12			VREDESTEIN Spacemaster



K7	GF40.10-P-1050-02KM	Survey of summer tires/disk wheels/recommended tire makes	Model 170 with code 990 AMG vehicles	GF
-----------	---------------------	---	--------------------------------------	-----------

Model	Tire designation	Disc wheel designation	Sheet-steel	Light-alloy	Recommended tire makes
AMG 170	225/45 ZR 17	7,5J x 17 H2 ET 37		X	CONTINENTAL Conti Sport Contact MICHELIN MXX 3 Pilot SX BRIDGESTONE Expedia S-01 ²⁾
	225/45 ZR 17	7,5J x 17 H2 ET 35		X	CONTINENTAL Conti Sport Contact MICHELIN MXX 3 Pilot SX BRIDGESTONE Expedia S-01 ²⁾
	VA 225/45 ZR 17 HA 245/40 ZR 17	VA 7,5J x 17 H2 ET 37 HA 8,5J x 17 H2 ET 30		X X	CONTINENTAL Conti Sport Contact MICHELIN MXX 3 Pilot SX BRIDGESTONE Expedia S-01 ²⁾
	VA 225/45 ZR 17 HA 245/40 ZR 17	VA 7,5J x 17 H2 ET 35 HA 8,5J x 17 H2 ET 30		X X	CONTINENTAL Conti Sport Contact MICHELIN MXX 3 Pilot SX BRIDGESTONE Expedia S-01 ²⁾

2) Also permissible: 225/45 ZR 17 93 W or 245/40 ZR 17 93W

L7	GF40.10-P-1050-02D	Survey of summer tires/disc wheels/recommended tire makes	Model 201	 GF
----	--------------------	---	-----------	--

Model	Tire designation	Disc wheel designation	Sheet-steel	Light-alloy	Recommended tire makes
201.018/023 /024/028	185/65 R 15 87 H 185/65 R 15 88 H	6Jx15 H2 ET 49 6,5Jx15 H2 ET 44	X	X X	CONTINENTAL Contact CH 90 DUNLOP SP Sport D8 MICHELIN MXV 3A PIRELLI P 2000 UNIROYAL rallye 440
Sports suspension	205/55 R 15 87 H	7Jx15 H2 ET 41 7Jx15 H2 ET 42 7Jx15 H2 ET 44	X	X X	MICHELIN MXV ⁹⁾ PIRELLI P 6
201.029	185/65 R 15 87 V 185/65 R 15 88 V	6Jx15 H2 ET 49 6,5Jx15 H2 ET 44	X	X X	CONTINENTAL Contact CV51 MICHELIN MXV 3A Pilot HX UNIROYAL rallye 440
Sports suspension	205/55 ZR 15	7Jx15 H2 ET 41 7Jx15 H2 ET 42 7Jx15 H2 ET 44	X	X X	MICHELIN MXV ⁹⁾ PIRELLI P 6
201.034/035	205/55 ZR 15	7Jx15 H2 ET 41 7Jx15 H2 ET 42 7Jx15 H2 ET 44	X	X X	MICHELIN MXV ⁹⁾ PIRELLI P 6
201.036 Evolution I	225/50 ZR 16	8Jx16 H2 ET 34		X	CONTINENTAL Contact CZ 91 PIRELLI P 700-ZN 1
201.036 Evolution II	245/40 ZR 17	8,25Jx17 H2 ET 34		X	DUNLOP SP Sport D40 M2
201.12 Sports suspension	205/55 R 15 87 H	7Jx15 H2 ET 41 7Jx15 H2 ET 42 7Jx15 H2 ET 44	X	X X	MICHELIN MXV ⁹⁾ PIRELLI P 6

9) For the Federal Republic of Germany only.

Model	Tire designation	Disc wheel designation	Sheet-steel	Light-alloy	Recommended tire makes
201.122/126	185/65 R 15 87 T 185/65 R 15 88 T	6Jx15 H2 ET 49 6,5Jx15 H2 ET 44	X	X X	CONTINENTAL Contact CT22 DUNLOP SP 9 GOODYEAR GT 2 MICHELIN MXT MICHELIN MXT Energy PIRELLI P 2000 UNIROYAL rallye 280/65 KLEBER C4T SEMPERIT HI-LIFE
201.128	185/65 R 15 87 H 185/65 R 15 88 H	6Jx15 H2 ET 49 6,5Jx15 H2 ET 44	X	X X	CONTINENTAL Contact CH 90 DUNLOP SP Sport D8 MICHELIN MXV 3A PIRELLI P 2000 UNIROYAL rallye 440

9) For the Federal Republic of Germany only.

N7	GF40.10-P-1050-02DM	Survey of summer tires/disk wheels/recommended tire makes	Model 201 with code 990 AMG vehicles	 GF
-----------	---------------------	---	--------------------------------------	---

Model	Tire designation	Disc wheel designation	Sheet-steel	Light-alloy	Recommended tire makes
AMG 201	225/45 ZR 16	7,5Jx16 H2 ET 31 7,5Jx16 H2 ET 37 7,5Jx16 H2 ET 40 7,5Jx16 H2 ET 41		X X X X	DUNLOP SP 8000 MFS MICHELIN MXX PIRELLI P 700-Z BRIDGESTONE RE 71
AMG 201.018/023 /024/028	205/55 R 15 87 H	7Jx15 H2 ET 35		X	MICHELIN MXV PIRELLI P 6
AMG 201.029	205/55 ZR 15	7Jx15 H2 ET 35		X	MICHELIN MXV PIRELLI P 6
with code 957	225/45 ZR 16	7,5Jx16 H2 ET 40 7,5Jx16 H2 ET 37		X X	DUNLOP SP 8000 MFS MICHELIN MXX PIRELLI P 700-Z BRIDGESTONE RE 71
AMG 201.12	205/55 R 15 87 H	7Jx15 H2 ET 35		X	MICHELIN MXV PIRELLI P 6

07	GF40.10-P-1050-02E	Survey of summer tires/disc wheels/recommended tire makes	Model 202	 GF
-----------	--------------------	---	-----------	--

Model	Tire designation	Disc wheel designation	Sheet-steel	Light-alloy	Recommended tire makes
202.018/020	185/65 R 15 88 H	6Jx15 H2 ET 31	X		CONTINENTAL Super Contact CH90 MICHELIN MXV 3A Energy PIRELLI P 2000 UNIROYAL Rallye 440
as of 09/95	195/65 R 15 91 H	6.5Jx15 H2 ET 37	X	X	CONTINENTAL Super Contact CH90 DUNLOP SP Sport 200 GOODYEAR Eagle Touring NCT 3 MICHELIN MXV 3A MICHELIN Engergy XH1 PIRELLI P 6000
	205/60 R 15 91 H	7Jx15 H2 ET37	X	X	CONTINENTAL Sport Contact CH90 DUNLOP SP Sport 200 GOODYEAR Eagle Touring NCT 3 PIRELLI P 6000
except C36 AMG	205/55 R 16 91 H	7Jx16 H2 ET 37		X	CONTINENTAL Conti Sport Contact MICHELIN MXM G1 Pilot HX PIRELLI P 6000
except C36 AMG	205/55 R 16 91 V	7Jx16 H2 ET 37		X	CONTINENTAL Conti Sport Contact MICHELIN MXM G1 Pilot HX PIRELLI P 6000
202.022	195/65 R 15 91 V	6.5Jx15 H2 ET 37	X	X	CONTINENTAL Super Contact CV90 DUNLOP SP Sport 200 GOODYEAR Eagle Touring NCT 3 MICHELIN MXV 3A Pilot HX MICHELIN Engergy XH1 PIRELLI P 6000

11) Conversion to 195/65 R 15 91 T tire is possible. Observe country-specific legislation for this. In the Federal Republic of Germany requires a certificate of non-objection from the plant and entry in the vehicle documents.

Model	Tire designation	Disc wheel designation	Sheet-steel	Light-alloy	Recommended tire makes
	205/60 R 15 91 V	7Jx15 H2 ET 37	X	X	CONTINENTAL Sport Contact CV90 DUNLOP SP Sport 200 GOODYEAR Eagle Touring NCT 3 PIRELLI P 6000
except C36 AMG	205/55 R 16 91 H	7Jx16 H2 ET 37		X	CONTINENTAL Conti Sport Contact MICHELIN MXM G1 Pilot HX PIRELLI P 6000
except C36 AMG	205/55 R 16 91 V	7Jx16 H2 ET 37		X	CONTINENTAL Conti Sport Contact MICHELIN MXM G1 Pilot HX PIRELLI P 6000
202.023	205/60 R 15 91 H	7Jx15 H2 ET37	X	X	CONTINENTAL Sport Contact CH90 DUNLOP SP Sport 200 GOODYEAR Eagle Touring NCT 3 PIRELLI P 6000
as of 09/95	195/65 R 15 91 H	6.5Jx15 H2 ET 37	X	X	CONTINENTAL Super Contact CH90 DUNLOP SP Sport 200 GOODYEAR Eagle Touring NCT 3 MICHELIN MXV 3A MICHELIN Engergy XH1 PIRELLI P 6000
except C36 AMG	205/55 R 16 91 H	7Jx16 H2 ET 37		X	CONTINENTAL Conti Sport Contact MICHELIN MXM G1 Pilot HX PIRELLI P 6000
except C36 AMG	205/55 R 16 91 V	7Jx16 H2 ET 37		X	CONTINENTAL Conti Sport Contact MICHELIN MXM G1 Pilot HX PIRELLI P 6000

11) Conversion to 195/65 R 15 91 T tire is possible. Observe country-specific legislation for this. In the Federal Republic of Germany requires a certificate of non-objection from the plant and entry in the vehicle documents.

Model	Tire designation	Disc wheel designation	Sheet-steel	Light-alloy	Recommended tire makes
202.024/025 /026/028 /029	195/65 R 15 91 V	6.5Jx15 H2 ET 37	X	X	CONTINENTAL Super Contact CV90 DUNLOP SP Sport 200 GOODYEAR Eagle Touring NCT 3 MICHELIN MXV 3A Pilot HX MICHELIN Energy XH1 PIRELLI P 6000
	205/60 R 15 91 V	7Jx15 H2 ET 37	X	X	CONTINENTAL Sport Contact CV90 DUNLOP SP Sport 200 GOODYEAR Eagle Touring NCT 3 MICHELIN MXM Pilot HX PIRELLI P 6000
except C36 AMG	205/55 R 16 91 V	7Jx16 H2 ET 37		X	CONTINENTAL Conti Sport Contact MICHELIN MXM G1 Pilot HX PIRELLI P 6000
202.078/080	205/60 R 15 91 H	7Jx15 H2 ET37	X	X	CONTINENTAL Sport Contact CH90 DUNLOP SP Sport 200 GOODYEAR Eagle Touring NCT 3 PIRELLI P 6000
as of 09/95	195/65 R 15 91 H	6.5Jx15 H2 ET 37	X	X	CONTINENTAL Super Contact CH90 DUNLOP SP Sport 200 GOODYEAR Eagle Touring NCT 3 MICHELIN MXV 3A MICHELIN Energy XH1 PIRELLI P 6000
except C36 AMG	205/55 R 16 91 H	7Jx16 H2 ET 37		X	CONTINENTAL Conti Sport Contact MICHELIN MXM G1 Pilot HX PIRELLI P 6000
except C36 AMG	205/55 R 16 91 V	7Jx16 H2 ET 37		X	CONTINENTAL Conti Sport Contact MICHELIN MXM G1 Pilot HX PIRELLI P 6000

11) Conversion to 195/65 R 15 91 T tire is possible. Observe country-specific legislation for this. In the Federal Republic of Germany requires a certificate of non-objection from the plant and entry in the vehicle documents.

Model	Tire designation	Disc wheel designation	Sheet-steel	Light-alloy	Recommended tire makes
202.081	195/65 R 15 91 H	6.5Jx15 H2 ET 37	X	X	CONTINENTAL Super Contact CH90 DUNLOP SP Sport 200 GOODYEAR Eagle Touring NCT 3 MICHELIN MXV 3A MICHELIN Engergy XH1 PIRELLI P 6000
	205/60 R 15 91 H	7Jx15 H2 ET37	X	X	CONTINENTAL Sport Contact CH90 DUNLOP SP Sport 200 GOODYEAR Eagle Touring NCT 3 PIRELLI P 6000
	205/55 R 16 91 H	7Jx16 H2 ET 37		X	CONTINENTAL Conti Sport Contact MICHELIN MXM G1 Pilot HX PIRELLI P 6000
202.082	195/65 R 15 91 V	6.5Jx15 H2 ET 37	X	X	CONTINENTAL Super Contact CV90 DUNLOP SP Sport 200 GOODYEAR Eagle Touring NCT 3 MICHELIN MXV 3A Pilot HX MICHELIN Engergy XH1 PIRELLI P 6000
	205/60 R 15 91 V	7Jx15 H2 ET 37	X	X	CONTINENTAL Sport Contact CV90 DUNLOP SP Sport 200 GOODYEAR Eagle Touring NCT 3 MICHELIN MXM Pilot HX PIRELLI P 6000
	except C36 AMG	205/55 R 16 91 V	7Jx16 H2 ET 37		X CONTINENTAL Conti Sport Contact MICHELIN MXM G1 Pilot HX PIRELLI P 6000

11) Conversion to 195/65 R 15 91 T tire is possible. Observe country-specific legislation for this. In the Federal Republic of Germany requires a certificate of non-objection from the plant and entry in the vehicle documents.

Model	Tire designation	Disc wheel designation	Sheet-steel	Light-alloy	Recommended tire makes
202.083	195/65 R 15 91 V	6.5Jx15 H2 ET 37	X	X	CONTINENTAL Super Contact CV90 DUNLOP SP Sport 200 GOODYEAR Eagle Touring NCT 3 MICHELIN MXV 3A Pilot HX MICHELIN Energy XH1 PIRELLI P 6000
	205/60 R 15 91 H	7Jx15 H2 ET37	X	X	CONTINENTAL Sport Contact CH90 DUNLOP SP Sport 200 GOODYEAR Eagle Touring NCT 3 PIRELLI P 6000
	205/60 R 15 91 V	7Jx15 H2 ET 37	X	X	CONTINENTAL Sport Contact CV90 DUNLOP SP Sport 200 GOODYEAR Eagle Touring NCT 3 PIRELLI P 6000
except C36 AMG	205/55 R 16 91 H	7Jx16 H2 ET 37		X	CONTINENTAL Conti Sport Contact MICHELIN MXM G1 Pilot HX PIRELLI P 6000
except C36 AMG	205/55 R 16 91 V	7Jx16 H2 ET 37		X	CONTINENTAL Conti Sport Contact MICHELIN MXM G1 Pilot HX PIRELLI P 6000
as of 09/95	195/65 R 15 91 H	6.5Jx15 H2 ET 37	X	X	CONTINENTAL Super Contact CH90 DUNLOP SP Sport 200 GOODYEAR Eagle Touring NCT 3 MICHELIN MXV 3A MICHELIN Energy XH1 PIRELLI P 6000

11) Conversion to 195/65 R 15 91 T tire is possible. Observe country-specific legislation for this. In the Federal Republic of Germany requires a certificate of non-objection from the plant and entry in the vehicle documents.

Model	Tire designation	Disc wheel designation	Sheet-steel	Light-alloy	Recommended tire makes
202.085/086 /089	195/65 R 15 91 V	6.5Jx15 H2 ET 37	X	X	CONTINENTAL Super Contact CV90 DUNLOP SP Sport 200 GOODYEAR Eagle Touring NCT 3 MICHELIN MXV 3A Pilot HX MICHELIN Energy XH1 PIRELLI P 6000
	205/60 R 15 91 V	7Jx15 H2 ET 37	X	X	CONTINENTAL Sport Contact CV90 DUNLOP SP Sport 200 GOODYEAR Eagle Touring NCT 3 MICHELIN MXM Pilot HX PIRELLI P 6000
except C36 AMG	205/55 R 16 91 V	7Jx16 H2 ET 37		X	CONTINENTAL Conti Sport Contact MICHELIN MXM G1 Pilot HX PIRELLI P 6000
202.120/121	185/65 R 15 88 T	6Jx15 H2 ET 31	X		CONTINENTAL Contact CT22 DUNLOP SP 9* GOODYEAR GT 2 MICHELIN MXT Energy PIRELLI P 2000
up to 02/94 ¹¹⁾	195/65 R 15 91 H	6.5Jx15 H2 ET 37	X	X	CONTINENTAL Super Contact CH90 DUNLOP SP Sport 200 GOODYEAR Eagle Touring NCT 3 MICHELIN MXV 3A MICHELIN Energy XH1 PIRELLI P 6000
as of 03/94	195/65 R 15 91 T	6.5Jx15 H2 ET 37	X	X	GOODYEAR GT 2 MICHELIN MXT Energy PIRELLI P 6000

11) Conversion to 195/65 R 15 91 T tire is possible. Observe country-specific legislation for this. In the Federal Republic of Germany requires a certificate of non-objection from the plant and entry in the vehicle documents.

Model	Tire designation	Disc wheel designation	Sheet-steel	Light-alloy	Recommended tire makes
	205/60 R 15 91 H	7Jx15 H2 ET37	X	X	CONTINENTAL Sport Contact CH90 DUNLOP SP Sport 200 GOODYEAR Eagle Touring NCT 3 PIRELLI P 6000
except C36 AMG	205/55 R 16 91 H	7Jx16 H2 ET 37		X	CONTINENTAL Conti Sport Contact MICHELIN MXM G1 Pilot HX PIRELLI P 6000
except C36 AMG	205/55 R 16 91 V	7Jx16 H2 ET 37		X	CONTINENTAL Conti Sport Contact MICHELIN MXM G1 Pilot HX PIRELLI P 6000
202.122	205/60 R 15 91 H	7Jx15 H2 ET37	X	X	CONTINENTAL Sport Contact CH90 DUNLOP SP Sport 200 GOODYEAR Eagle Touring NCT 3 PIRELLI P 6000
as of 03/94	195/65 R 15 91 T	6.5Jx15 H2 ET 37	X	X	GOODYEAR GT 2 MICHELIN MXT Energy PIRELLI P 6000
except C36 AMG	205/55 R 16 91 H	7Jx16 H2 ET 37		X	CONTINENTAL Conti Sport Contact MICHELIN MXM G1 Pilot HX PIRELLI P 6000
except C36 AMG	205/55 R 16 91 V	7Jx16 H2 ET 37		X	CONTINENTAL Conti Sport Contact MICHELIN MXM G1 Pilot HX PIRELLI P 6000
202.125	185/65 R 15 88 H	6Jx15 H2 ET 31	X		CONTINENTAL Super Contact CH90 MICHELIN MXV 3A Energy PIRELLI P 2000 UNIROYAL Rallye 440

11) Conversion to 195/65 R 15 91 T tire is possible. Observe country-specific legislation for this. In the Federal Republic of Germany requires a certificate of non-objection from the plant and entry in the vehicle documents.

Model	Tire designation	Disc wheel designation	Sheet-steel	Light-alloy	Recommended tire makes
as of 09/95	195/65 R 15 91 H	6.5Jx15 H2 ET 37	X	X	CONTINENTAL Super Contact CH90 DUNLOP SP Sport 200 GOODYEAR Eagle Touring NCT 3 MICHELIN MXV 3A MICHELIN Engergy XH1 PIRELLI P 6000
	205/60 R 15 91 H	7Jx15 H2 ET37	X	X	CONTINENTAL Sport Contact CH90 DUNLOP SP Sport 200 GOODYEAR Eagle Touring NCT 3 PIRELLI P 6000
except C36 AMG	205/55 R 16 91 H	7Jx16 H2 ET 37		X	CONTINENTAL Conti Sport Contact MICHELIN MXM G1 Pilot HX PIRELLI P 6000
except C36 AMG	205/55 R 16 91 V	7Jx16 H2 ET 37		X	CONTINENTAL Conti Sport Contact MICHELIN MXM G1 Pilot HX PIRELLI P 6000
202.128	205/60 R 15 91 H	7Jx15 H2 ET37	X	X	CONTINENTAL Sport Contact CH90 DUNLOP SP Sport 200 GOODYEAR Eagle Touring NCT 3 PIRELLI P 6000
as of 09/95	195/65 R 15 91 H	6.5Jx15 H2 ET 37	X	X	CONTINENTAL Super Contact CH90 DUNLOP SP Sport 200 GOODYEAR Eagle Touring NCT 3 MICHELIN MXV 3A MICHELIN Engergy XH1 PIRELLI P 6000
except C36 AMG	205/55 R 16 91 H	7Jx16 H2 ET 37		X	CONTINENTAL Conti Sport Contact MICHELIN MXM G1 Pilot HX PIRELLI P 6000

11) Conversion to 195/65 R 15 91 T tire is possible. Observe country-specific legislation for this. In the Federal Republic of Germany requires a certificate of non-objection from the plant and entry in the vehicle documents.

Model	Tire designation	Disc wheel designation	Sheet-steel	Light-alloy	Recommended tire makes
except C36 AMG	205/55 R 16 91 V	7Jx16 H2 ET 37		X	CONTINENTAL Conti Sport Contact MICHELIN MXM G1 Pilot HX PIRELLI P 6000
202.133	195/65 R 15 91 H	6.5Jx15 H2 ET 37	X	X	CONTINENTAL Super Contact CH90 DUNLOP SP Sport 200 GOODYEAR Eagle Touring NCT 3 MICHELIN MXV 3A MICHELIN Energy XH1 PIRELLI P 6000
	205/60 R 15 91 H	7Jx15 H2 ET37	X	X	CONTINENTAL Sport Contact CH90 DUNLOP SP Sport 200 GOODYEAR Eagle Touring NCT 3 PIRELLI P 6000
	205/55 R 16 91 H	7Jx16 H2 ET 37		X	CONTINENTAL Conti Sport Contact MICHELIN MXM G1 Pilot HX PIRELLI P 6000
	205/55 R 16 91 V	7Jx16 H2 ET 37		X	CONTINENTAL Conti Sport Contact MICHELIN MXM G1 Pilot HX PIRELLI P 6000
202.134	195/65 R 15 91 T	6.5Jx15 H2 ET 37	X	X	GOODYEAR GT 2 MICHELIN MXT Energy PIRELLI P 6000
	205/60 R 15 91 H	7Jx15 H2 ET 37	X	X	CONTINENTAL Sport Contact CH90 DUNLOP SP Sport 200 GOODYEAR Eagle Touring NCT 3 PIRELLI P 6000
	205/55 R 16 91 H	7Jx16 H2 ET 37		X	CONTINENTAL Conti Sport Contact MICHELIN MXM G1 Pilot HX PIRELLI P 6000

11) Conversion to 195/65 R 15 91 T tire is possible. Observe country-specific legislation for this. In the Federal Republic of Germany requires a certificate of non-objection from the plant and entry in the vehicle documents.



Model	Tire designation	Disc wheel designation	Sheet-steel	Light-alloy	Recommended tire makes
202.180/182	195/65 R 15 91 T	6.5Jx15 H2 ET 37	X	X	GOODYEAR GT 2 MICHELIN MXT Energy PIRELLI P 6000
	205/60 R 15 91 H	7Jx15 H2 ET37	X	X	CONTINENTAL Sport Contact CH90 DUNLOP SP Sport 200 GOODYEAR Eagle Touring NCT 3 PIRELLI P 6000
except C36 AMG	205/55 R 16 91 H	7Jx16 H2 ET 37		X	CONTINENTAL Conti Sport Contact MICHELIN MXM G1 Pilot HX PIRELLI P 6000
except C36 AMG	205/55 R 16 91 V	7Jx16 H2 ET 37		X	CONTINENTAL Conti Sport Contact MICHELIN MXM G1 Pilot HX PIRELLI P 6000
202.188	205/60 R 15 91 H	7Jx15 H2 ET37	X	X	CONTINENTAL Sport Contact CH90 DUNLOP SP Sport 200 GOODYEAR Eagle Touring NCT 3 PIRELLI P 6000
as of 09/95	195/65 R 15 91 H	6.5Jx15 H2 ET 37	X	X	CONTINENTAL Super Contact CH90 DUNLOP SP Sport 200 GOODYEAR Eagle Touring NCT 3 MICHELIN MXV 3A MICHELIN Engergy XH1 PIRELLI P 6000
except C36 AMG	205/55 R 16 91 H	7Jx16 H2 ET 37		X	CONTINENTAL Conti Sport Contact MICHELIN MXM G1 Pilot HX PIRELLI P 6000
except C36 AMG	205/55 R 16 91 V	7Jx16 H2 ET 37		X	CONTINENTAL Conti Sport Contact MICHELIN MXM G1 Pilot HX PIRELLI P 6000

11) Conversion to 195/65 R 15 91 T tire is possible. Observe country-specific legislation for this. In the Federal Republic of Germany requires a certificate of non-objection from the plant and entry in the vehicle documents.

Model	Tire designation	Disc wheel designation	Sheet-steel	Light-alloy	Recommended tire makes
202.193	195/65 R 15 91 H	6.5Jx15 H2 ET 37	X	X	CONTINENTAL Super Contact CH90 DUNLOP SP Sport 200 GOODYEAR Eagle Touring NCT 3 MICHELIN MXV 3A MICHELIN Energy XH1 PIRELLI P 6000
	205/60 R 15 91 H	7Jx15 H2 ET37	X	X	CONTINENTAL Sport Contact CH90 DUNLOP SP Sport 200 GOODYEAR Eagle Touring NCT 3 PIRELLI P 6000
	205/55 R 16 91 H	7Jx16 H2 ET 37		X	CONTINENTAL Conti Sport Contact MICHELIN MXM G1 Pilot HX PIRELLI P 6000
	205/55 R 16 91 V	7Jx16 H2 ET 37		X	CONTINENTAL Conti Sport Contact MICHELIN MXM G1 Pilot HX PIRELLI P 6000
202.194	195/65 R 15 91 T	6.5Jx15 H2 ET 37	X	X	GOODYEAR GT 2 MICHELIN MXT MICHELIN MXT Energy PIRELLI P 6000
	205/60 R 15 91 H	7Jx15 H2 ET37	X	X	CONTINENTAL Sport Contact CH90 DUNLOP SP Sport 200 GOODYEAR Eagle Touring NCT 3 PIRELLI P 6000
	205/55 R 16 91 H	7Jx16 H2 ET 37		X	CONTINENTAL Conti Sport Contact MICHELIN MXM G1 Pilot HX PIRELLI P 6000

11) Conversion to 195/65 R 15 91 T tire is possible. Observe country-specific legislation for this. In the Federal Republic of Germany requires a certificate of non-objection from the plant and entry in the vehicle documents.

K8	GF40.10-P-1050-02EM	Survey of summer tires/disk wheels/recommended tire makes	Model 202 with code 990 AMG vehicles	 GF
-----------	---------------------	---	--------------------------------------	---

Model	Tire designation	Disc wheel designation	Sheet-steel	Light-alloy	Recommended tire makes
AMG 202 C28 (series production)	205/60 R 15 91V	7Jx15 H2 ET 37		X	PIRELLI P 6000 CONTINENTAL Sport Contact CV 90 DUNLOP SP Sport 200 GOODYEAR Eagle Touring NCT 3 MICHELIN MXM Pilot HX
AMG 202	225/45 ZR 17	7,5Jx17 H2 ET 37		X	BRIDGESTONE S01 CONTINENTAL Conti Sport Contact MICHELIN MXX 3 Pilot SX
	225/45 ZR 17	7,5Jx17 H2 ET 35		X	BRIDGESTONE S01 CONTINENTAL Conti Sport Contact MICHELIN MXX 3 Pilot SX
	VA: 225/45 ZR 17 HA: 245/40 ZR 17	VA: 7,5Jx17 H2 ET 37 HA: 8,5Jx17 H2 ET 30		X X	BRIDGESTONE S01 MICHELIN MXX 3 Pilot SX CONTINENTAL Conti Sport Contact
	VA: 225/45 ZR 17 HA: 245/40 ZR 17	VA: 7,5Jx17 H2 ET 35 HA: 8,5Jx17 H2 ET 30		X X	BRIDGESTONE S01 MICHELIN MXX 3 Pilot SX CONTINENTAL Conti Sport Contact
AMG only models 202.018/020 /078/080 /083/120 /121/122 /125/128 /182/188	205/60 R 15 91 H	7Jx15 H2 ET 37		X	CONTINENTAL Sport Contact CH 90 DUNLOP SP Sport 200 GOODYEAR Eagle Touring NCT 3 PIRELLI P 6000

2) Also permissible: 225/45 ZR 17 93W or 245/40 ZR 17 93 W

3) Approved up to max. 80 km/h



Model	Tire designation	Disc wheel designation	Sheet-steel	Light-alloy	Recommended tire makes
AMG 202 C43 (Spare wheel)	215/45 ZR 17 ³⁾	7.5Jx17 H2 ET 35		X	CONTINENTAL Conti Sport Contact

2) Also permissible: 225/45 ZR 17 93W or 245/40 ZR 17 93 W

3) Approved up to max. 80 km/h



M8	GF40.10-P-1050-020	Survey of summer tires/disk wheels/recommended tire makes	Model 208	GF
-----------	--------------------	---	-----------	----

Model	Tire designation	Disc wheel designation	Sheet-steel	Light-alloy	Recommended tire makes
208.335	205/55 R 16 91 H	7Jx16 H2 ET 37		X	CONTINENTAL Conti Sport Contact MICHELIN MXM G1 Pilot HX PIRELLI P 6000
	205/55 R 16 91 V	7Jx16 H2 ET 37		X	CONTINENTAL Conti Sport Contact MICHELIN MXM G1 Pilot HX PIRELLI P 6000
	FA 205/55 R 16 91 V RA 225/50 R 16 92 V	FA 7Jx16 H2 ET 37 RA 8Jx16 H2 ET 36		X	FA MICHELIN MXM G1 Pilot HX RA MICHELIN MXM Pilot HX PIRELLI P 6000 CONTINENTAL Sport Contact
208.345/347	205/55 R 16 91 V	7Jx16 H2 ET 37		X	CONTINENTAL Conti Sport Contact MICHELIN MXM G1 Pilot HX PIRELLI P 6000
	FA 205/55 R 16 91 V RA 225/50 R 16 92 V	FA 7Jx16 H2 ET 37 RA 8Jx16 H2 ET 36		X	FA MICHELIN MXM G1 Pilot HX RA MICHELIN MXM Pilot HX PIRELLI P 6000 CONTINENTAL Sport Contact
208.365/370	205/55 R 16 91 W	7Jx16 H2 ET 37		X	CONTINENTAL Conti Sport Contact MICHELIN MXM G1 Pilot HX PIRELLI P 6000
208.370 up to CY 99/1	FA 205/55 R 16 91 W RA 225/50 R 16 92 W	FA 7Jx16 H2 ET 37 RA 8Jx16 H2 ET 36		X	FA MICHELIN MXM G1 Pilot HX RA MICHELIN MXM Pilot HX PIRELLI P 6000 CONTINENTAL Sport Contact

Model	Tire designation	Disc wheel designation	Sheet-steel	Light-alloy	Recommended tire makes
208.435	205/55 R 16 91 H	7Jx16 H2 ET 37		X	CONTINENTAL Conti Sport Contact MICHELIN MXM G1 Pilot HX
	205/55 R 16 91 V	7Jx16 H2 ET 37		X	CONTINENTAL Conti Sport Contact MICHELIN MXM G1 Pilot HX
	FA 205/55 R 16 91 V RA 225/50 R 16 92 V	FA 7Jx16 H2 ET 37 RA 8Jx16 H2 ET 36		X	FA MICHELIN MXM G1 Pilot HX RA MICHELIN MXM Pilot HX CONTINENTAL Sport Contact
208.445/447	205/55 R 16 91 V	7Jx16 H2 ET 37		X	CONTINENTAL Conti Sport Contact MICHELIN MXM G1 Pilot HX
	FA 205/55 R 16 91 V RA 225/50 R 16 92 V	FA 7Jx16 H2 ET 37 RA 8Jx16 H2 ET 36		X	FA MICHELIN MXM G1 Pilot HX RA MICHELIN MXM Pilot HX CONTINENTAL Sport Contact
208.465/470	205/55 R 16 91 W	7Jx16 H2 ET 37		X	CONTINENTAL Conti Sport Contact MICHELIN MXM G1 Pilot HX
	FA 205/55 R 16 91 W RA 225/50 R 16 92 W	FA 7Jx16 H2 ET 37 RA 8Jx16 H2 ET 36		X	FA MICHELIN MXM G1 Pilot HX RA MICHELIN MXM Pilot HX CONTINENTAL Sport Contact



08 GF40.10-P-1050-02OM	Survey of summer tires/disk wheels/recommended tire makes	Model 208 with code 990 AMG vehicles	 GF
-------------------------------	---	--------------------------------------	---

Model	Tire designation	Disc wheel designation	Sheet-steel	Light-alloy	Recommended tire makes
AMG 208	225/45 ZR 17	7,5Jx17 ET 37		X	BRIDGESTONE S01 CONTINENTAL Conti Sport Contact MICHELIN MXX 3 Pilot SX
	225/45 ZR 17	7,5Jx17 ET 35		X	BRIDGESTONE S01 CONTINENTAL Conti Sport Contact MICHELIN MXX 3 Pilot SX
	VA: 225/45 ZR 17 HA: 245/40 ZR 17	VA: 7,5Jx17 ET 37 HA: 8,5Jx17 ET 30		X X	BRIDGESTONE S01 CONTINENTAL Conti Sport Contact MICHELIN MXX 3 Pilot SX
	VA: 225/45 ZR 17 HA: 245/40 ZR 17	VA: 7,5Jx17 ET 35 HA: 8,5Jx17 ET 30		X X	BRIDGESTONE S01 CONTINENTAL Conti Sport Contact MICHELIN MXX 3 Pilot SX



P8	GF40.10-P-1050-02F	Survey of summer tires/disc wheels/recommended tire makes	Model 210	 GF
-----------	--------------------	---	-----------	--

Survey of summer tires/disc wheels/recommended tire makes

Model	Tire designation	Disc wheel designation	Sheet-steel	Light-alloy	Recommended tire makes
210.003/004	195/65 R 15 91 T	6.5Jx15 H2 ET 37	X	X	GOODYEAR GT-2 MICHELIN MXT Energy PIRELLI P 6000
	205/65 R 15 94 H	7Jx15 H2 ET 37	X	X	CONTINENTAL Eco Contact CP DUNLOP SP Sport 200 GOODYEAR Eagle Touring NCT 3 MICHELIN MXV 3A Energy PIRELLI P 6000
	205/65 R 15 94 V	7Jx15 H2 ET 37	X	X	CONTINENTAL Eco Contact CP DUNLOP SP Sport 200 MICHELIN MXV 3A Pilot HX PIRELLI P 6000
	215/55 R 16 93 H	7.5Jx16 H2 ET 41	X	X	CONTINENTAL Eco Contact CP DUNLOP SP Sport 2020 E GOODYEAR Eagle Touring NCT 3 MICHELIN MXV 3A Energy PIRELLI P 6000
	215/55 R 16 93 V	7.5Jx16 H2 ET 41	X	X	CONTINENTAL Eco Contact CP GOODYEAR Eagle Touring NCT 3 MICHELIN MXV 3A Pilot HX PIRELLI P 6000
	215/55 R 16 93 W	7.5Jx16 H2 ET 41	X	X	CONTINENTAL Eco Contact CP GOODYEAR Eagle Touring NCT 3 MICHELIN MXV 3A Pilot HX PIRELLI P 6000

- 1) Approved with dimensions 235/45R 17 94 W
- 2) Dual designation 235/45 ZR 17 94 Y
- 3) Not in conjunction with ESP
- 4) Tire approval being prepared



Model	Tire designation	Disc wheel designation	Sheet-steel	Light-alloy	Recommended tire makes
	235/45 R 17 93 W	8Jx17 H2 ET 37		X	CONTINENTAL Conti Sport Contact ¹⁾ DUNLOP SP Sport 9000 ¹⁾ GOODYEAR Eagle F1 MICHELIN MXX 3 Pilot SX ²⁾ PIRELLI P 6000 ²⁾
	235/45 R 17 94 W	8Jx17 H2 ET 37		X	CONTINENTAL Sport Contact ¹⁾ DUNLOP SP Sport 9000 ¹⁾ GOODYEAR Eagle F1 MICHELIN MXX 3 Pilot SX ²⁾ PIRELLI P 6000 ²⁾
210.006/007 up to CY 99/1 (07/99)	205/65 R 15 94 H	7Jx15 H2 ET 37	X	X	CONTINENTAL Eco Contact CP DUNLOP SP Sport 200 GOODYEAR Eagle Touring NCT 3 MICHELIN MXV 3A Energy PIRELLI P 6000
	205/65 R 15 94 V	7Jx15 H2 ET 37	X	X	CONTINENTAL Eco Contact CP DUNLOP SP Sport 200 MICHELIN MXV 3A Pilot HX PIRELLI P 6000
up to CY 99/1 (07/99)	215/55 R 16 93 H	7.5Jx16 H2 ET 41	X	X	CONTINENTAL Eco Contact CP DUNLOP SP Sport 2020 E GOODYEAR Eagle Touring NCT 3 MICHELIN MXV 3A Energy PIRELLI P 6000
	215/55 R 16 93 V	7.5Jx16 H2 ET 41	X	X	CONTINENTAL Eco Contact CP DUNLOP SP Sport 2020 E GOODYEAR Eagle Touring NCT 3 MICHELIN MXV 3A Pilot HX PIRELLI P 6000

1) Approved with dimensions 235/45R 17 94 W

2) Dual designation 235/45 ZR 17 94 Y

3) Not in conjunction with ESP

4) Tire approval being prepared



Model	Tire designation	Disc wheel designation	Sheet-steel	Light-alloy	Recommended tire makes
	215/55 R 16 93 W	7.5Jx16 H2 ET 41	X	X	CONTINENTAL Eco Contact CP GOODYEAR Eagle Touring NCT 3 MICHELIN MXV 3A Pilot HX PIRELLI P 6000
	235/45 R 17 93 W	8Jx17 H2 ET 37		X	CONTINENTAL Conti Sport Contact ¹⁾ DUNLOP SP Sport 9000 ¹⁾ GOODYEAR Eagle F1 MICHELIN MXX 3 Pilot SX ²⁾ PIRELLI P 6000 ²⁾
	235/45 R 17 94 W	8Jx17 H2 ET 37		X	CONTINENTAL Sport Contact ¹⁾ DUNLOP SP Sport 9000 ¹⁾ GOODYEAR Eagle F1 MICHELIN MXX 3 Pilot SX ²⁾ PIRELLI P 6000 ²⁾
210.010	195/65 R 15 91 H	6.5Jx15 H2 ET 37	X	X	CONTINENTAL Super Contact CH 90 DUNLOP SP Sport 200 GOODYEAR Eagle Touring NCT 3 MICHELIN MXV 3A MICHELIN ENERGY XH1 PIRELLI P 6000
	205/65 R 15 94 H	7Jx15 H2 ET 37	X	X	CONTINENTAL Eco Contact CP DUNLOP SP Sport 200 GOODYEAR Eagle Touring NCT 3 MICHELIN MXV 3A Energy PIRELLI P 6000
	205/65 R 15 94 V	7Jx15 H2 ET 37	X	X	CONTINENTAL Eco Contact CP DUNLOP SP Sport 200 MICHELIN MXV 3A Pilot HX PIRELLI P 6000

1) Approved with dimensions 235/45R 17 94 W

2) Dual designation 235/45 ZR 17 94 Y

3) Not in conjunction with ESP

4) Tire approval being prepared



Model	Tire designation	Disc wheel designation	Sheet-steel	Light-alloy	Recommended tire makes
	215/55 R 16 93 H	7.5Jx16 H2 ET 41	X	X	CONTINENTAL Eco Contact CP DUNLOP SP Sport 2020 E GOODYEAR Eagle Touring NCT 3 MICHELIN MXV 3A Energy PIRELLI P 6000
	215/55 R 16 93 V	7.5Jx16 H2 ET 41	X	X	CONTINENTAL Eco Contact CP GOODYEAR Eagle Touring NCT 3 MICHELIN MXV 3A Pilot HX PIRELLI P 6000
	215/55 R 16 93 W	7.5Jx16 H2 ET 41	X	X	CONTINENTAL Eco Contact CP GOODYEAR Eagle Touring NCT 3 MICHELIN MXV 3A Pilot HX PIRELLI P 6000
	235/45 R 17 93 W	8Jx17 H2 ET 37		X	CONTINENTAL Conti Sport Contact ¹⁾ DUNLOP SP Sport 9000 ¹⁾ GOODYEAR Eagle F1 MICHELIN MXX 3 Pilot SX ²⁾ PIRELLI P 6000 ²⁾
	235/45 R 17 94 W	8Jx17 H2 ET 37		X	CONTINENTAL Sport Contact ¹⁾ DUNLOP SP Sport 9000 ¹⁾ GOODYEAR Eagle F1 MICHELIN MXX 3 Pilot SX ²⁾ PIRELLI P 6000 ²⁾
210.015/017 020	205/65 R 15 94 H	7Jx15 H2 ET 37	X	X	CONTINENTAL Eco Contact CP DUNLOP SP Sport 200 GOODYEAR Eagle Touring NCT 3 MICHELIN MXV 3A Energy PIRELLI P 6000

1) Approved with dimensions 235/45R 17 94 W

2) Dual designation 235/45 ZR 17 94 Y

3) Not in conjunction with ESP

4) Tire approval being prepared

Model	Tire designation	Disc wheel designation	Sheet-steel	Light-alloy	Recommended tire makes
	205/65 R 15 94 V	7Jx15 H2 ET 37	X	X	CONTINENTAL Eco Contact CP DUNLOP SP Sport 200 MICHELIN MXV 3A Pilot HX PIRELLI P 6000
	215/55 R 16 93 H	7.5Jx16 H2 ET 41	X	X	CONTINENTAL Eco Contact CP DUNLOP SP Sport 2020 E GOODYEAR Eagle Touring NCT 3 MICHELIN MXV 3A Energy PIRELLI P 6000
	215/55 R 16 93 V	7.5Jx16 H2 ET 41	X	X	CONTINENTAL Eco Contact CP GOODYEAR Eagle Touring NCT 3 MICHELIN MXV 3A Pilot HX PIRELLI P 6000
	215/55 R 16 93 W	7.5Jx16 H2 ET 41	X	X	CONTINENTAL Eco Contact CP GOODYEAR Eagle Touring NCT 3 MICHELIN MXV 3A Pilot HX PIRELLI P 6000
	235/45 R 17 93 W	8Jx17 H2 ET 37		X	CONTINENTAL Conti Sport Contact ¹⁾ DUNLOP SP Sport 9000 ¹⁾ GOODYEAR Eagle F1 MICHELIN MXX 3 Pilot SX ²⁾ PIRELLI P 6000 ²⁾
	235/45 R 17 94 W	8Jx17 H2 ET 37		X	CONTINENTAL Sport Contact ¹⁾ DUNLOP SP Sport 9000 ¹⁾ GOODYEAR Eagle F1 MICHELIN MXX 3 Pilot SX ²⁾ PIRELLI P 6000 ²⁾

1) Approved with dimensions 235/45R 17 94 W

2) Dual designation 235/45 ZR 17 94 Y

3) Not in conjunction with ESP

4) Tire approval being prepared



Model	Tire designation	Disc wheel designation	Sheet-steel	Light-alloy	Recommended tire makes
210.016	215/55 R 16 93 V	7.5Jx16 H2 ET 41	X	X	CONTINENTAL Eco Contact CP DUNLOP SP Sport 2020 E GOODYEAR Eagle Touring NCT 3 MICHELIN MXV 3A Pilot HX PIRELLI P 6000
	235/45 R 17 93 W	8Jx17 H2 ET 37		X	CONTINENTAL Conti Sport Contact ¹⁾ DUNLOP SP Sport 9000 ¹⁾ GOODYEAR Eagle F1 MICHELIN MXX 3 Pilot SX ²⁾ PIRELLI P 6000 ²⁾
	235/45 R 17 94 W	8Jx17 H2 ET 37		X	CONTINENTAL Sport Contact ¹⁾ DUNLOP SP Sport 9000 ¹⁾ GOODYEAR Eagle F1 MICHELIN MXX 3 Pilot SX ²⁾ PIRELLI P 6000 ²⁾
210.025	215/55 R 16 93 W	7.5Jx16 H2 ET 41	X	X	CONTINENTAL Eco Contact CP GOODYEAR Eagle Touring NCT 3 MICHELIN MXV 3A Pilot HX PIRELLI P 6000
	235/45 R 17 93 W	8Jx17 H2 ET 37		X	CONTINENTAL Conti Sport Contact ¹⁾ DUNLOP SP Sport 9000 ¹⁾ GOODYEAR Eagle F1 MICHELIN MXX 3 Pilot SX ²⁾ PIRELLI P 6000 ²⁾
	235/45 R 17 94 W	8Jx17 H2 ET 37		X	CONTINENTAL Sport Contact ¹⁾ DUNLOP SP Sport 9000 ¹⁾ GOODYEAR Eagle F1 MICHELIN MXX 3 Pilot SX ²⁾ PIRELLI P 6000 ²⁾

1) Approved with dimensions 235/45R 17 94 W

2) Dual designation 235/45 ZR 17 94 Y

3) Not in conjunction with ESP

4) Tire approval being prepared

Model	Tire designation	Disc wheel designation	Sheet-steel	Light-alloy	Recommended tire makes
as of 01/98	215/55 R 16 93 V	7.5Jx16 H2 ET 41	X	X	CONTINENTAL Eco Contact CP DUNLOP SP Sport 2020 E GOODYEAR Eagle Touring NCT 3 MICHELIN MXV 3A Pilot HX PIRELLI P 6000
210.026	215/55 R 16 93 V	7.5Jx16 H2 ET 41	X	X	CONTINENTAL Eco Contact CP DUNLOP SP Sport 2020 E GOODYEAR Eagle Touring NCT 3 MICHELIN MXV 3A Pilot HX PIRELLI P 6000
	235/45 R 17 93 W	8Jx17 H2 ET 37		X	CONTINENTAL Conti Sport Contact ¹⁾ DUNLOP SP Sport 9000 ¹⁾ GOODYEAR Eagle F1 MICHELIN MXX 3 Pilot SX ²⁾ PIRELLI P 6000 ²⁾
	235/45 R 17 94 W	8Jx17 H2 ET 37		X	CONTINENTAL Sport Contact ¹⁾ DUNLOP SP Sport 9000 ¹⁾ GOODYEAR Eagle F1 MICHELIN MXX 3 Pilot SX ²⁾ PIRELLI P 6000 ²⁾
210.035	195/65 R 15 91 H	6.5Jx15 H2 ET 37	X	X	CONTINENTAL Super Contact CH 90 DUNLOP SP Sport 200 GOODYEAR Eagle Touring NCT 3 MICHELIN MXV 3A MICHELIN ENERGY XH1 PIRELLI P 6000
Production as of CY 99/1 (07/99)	205/65 R 15 94 H	7Jx15 H2 ET 37	X	X	CONTINENTAL Eco Contact CP DUNLOP SP Sport 200 GOODYEAR Eagle Touring NCT 3 MICHELIN MXV 3A Energy PIRELLI P 6000

1) Approved with dimensions 235/45R 17 94 W

2) Dual designation 235/45 ZR 17 94 Y

3) Not in conjunction with ESP

4) Tire approval being prepared



Model	Tire designation	Disc wheel designation	Sheet-steel	Light-alloy	Recommended tire makes
	205/65 R 15 94 V	7Jx15 H2 ET 37	X	X	CONTINENTAL Eco Contact CP DUNLOP SP Sport 200 MICHELIN MXV 3A Pilot HX PIRELLI P 6000
	215/55 R 16 93 H	7.5Jx16 H2 ET 41	X	X	CONTINENTAL Eco Contact CP DUNLOP SP Sport 2020 E GOODYEAR Eagle Touring NCT 3 MICHELIN MXV 3A Energy PIRELLI P 6000
	215/55 R 16 93 V	7.5Jx16 H2 ET 41	X	X	CONTINENTAL Eco Contact CP GOODYEAR Eagle Touring NCT 3 MICHELIN MXV 3A Pilot HX PIRELLI P 6000
	215/55 R 16 93 W	7.5Jx16 H2 ET 41	X	X	CONTINENTAL Eco Contact CP GOODYEAR Eagle Touring NCT 3 MICHELIN MXV 3A Pilot HX PIRELLI P 6000
	235/45 R 17 93 W	8Jx17 H2 ET 37		X	CONTINENTAL Conti Sport Contact ¹⁾ DUNLOP SP Sport 9000 ¹⁾ GOODYEAR Eagle F1 MICHELIN MXX 3 Pilot SX ²⁾ PIRELLI P 6000 ²⁾
	235/45 R 17 94 W	8Jx17 H2 ET 37		X	CONTINENTAL Sport Contact ¹⁾ DUNLOP SP Sport 9000 ¹⁾ GOODYEAR Eagle F1 MICHELIN MXX 3 Pilot SX ²⁾ PIRELLI P 6000 ²⁾

1) Approved with dimensions 235/45R 17 94 W

2) Dual designation 235/45 ZR 17 94 Y

3) Not in conjunction with ESP

4) Tire approval being prepared



Model	Tire designation	Disc wheel designation	Sheet-steel	Light-alloy	Recommended tire makes
210.037	195/65 R 15 91 V	6.5Jx15 H2 ET 37	X	X	CONTINENTAL Super Contact CV 90 DUNLOP SP Sport 200 GOODYEAR Eagle Touring NCT 3 MICHELIN MXV 3A Pilot HX MICHELIN ENERGY XH1 PIRELLI P 6000
	205/65 R 15 94 V	7Jx15 H2 ET 37	X	X	CONTINENTAL Eco Contact CP DUNLOP SP Sport 200 MICHELIN MXV 3A Pilot HX PIRELLI P 6000
	215/55 R 16 93 V	7.5Jx16 H2 ET 41	X	X	CONTINENTAL Eco Contact CP GOODYEAR Eagle Touring NCT 3 MICHELIN MXV 3A Pilot HX PIRELLI P 6000
	215/55 R 16 93 W	7.5Jx16 H2 ET 41	X	X	CONTINENTAL Eco Contact CP GOODYEAR Eagle Touring NCT 3 MICHELIN MXV 3A Pilot HX PIRELLI P 6000
	235/45 R 17 93 W	8Jx17 H2 ET 37		X	CONTINENTAL Conti Sport Contact ¹⁾ DUNLOP SP Sport 9000 ¹⁾ GOODYEAR Eagle F1 MICHELIN MXX 3 Pilot SX ²⁾ PIRELLI P 6000 ²⁾
210.045	215/55 R 16 93 W	7.5Jx16 H2 ET 41	X	X	CONTINENTAL Eco Contact CP GOODYEAR Eagle Touring NCT 3 MICHELIN MXV 3A Pilot HX PIRELLI P 6000

1) Approved with dimensions 235/45R 17 94 W

2) Dual designation 235/45 ZR 17 94 Y

3) Not in conjunction with ESP

4) Tire approval being prepared

Model	Tire designation	Disc wheel designation	Sheet-steel	Light-alloy	Recommended tire makes
	235/45 R 17 93 W	8Jx17 H2 ET 37		X	CONTINENTAL Conti Sport Contact ¹⁾ DUNLOP SP Sport 9000 ¹⁾ GOODYEAR Eagle F1 MICHELIN MXX 3 Pilot SX ²⁾ PIRELLI P 6000 ²⁾
	235/45 R 17 94 W	8Jx17 H2 ET 37		X	CONTINENTAL Sport Contact ¹⁾ DUNLOP SP Sport 9000 ¹⁾ GOODYEAR Eagle F1 MICHELIN MXX 3 Pilot SX ²⁾ PIRELLI P 6000 ²⁾
as of 01/98	215/55 R 16 93 V	7.5Jx16 H2 ET 41	X	X	CONTINENTAL Eco Contact CP DUNLOP SP Sport 2020 E GOODYEAR Eagle Touring NCT 3 MICHELIN MXV 3A Pilot HX PIRELLI P 6000
210.053/055	215/55 R 16 93 W	7.5Jx16 H2 ET 41	X	X	CONTINENTAL Eco Contact CP GOODYEAR Eagle Touring NCT 3 MICHELIN MXV 3A Pilot HX PIRELLI P 6000
	235/45 R 17 93 W	8Jx17 H2 ET 37		X	CONTINENTAL Conti Sport Contact ¹⁾ DUNLOP SP Sport 9000 ¹⁾ GOODYEAR Eagle F1 MICHELIN MXX 3 Pilot SX ²⁾ PIRELLI P 6000 ²⁾
210.061	205/65 R 15 94 V ³⁾	7Jx15 H2 ET 37	X	X	CONTINENTAL Eco Contact CP DUNLOP SP Sport 200 MICHELIN MXV 3A Pilot HX PIRELLI P 6000

1) Approved with dimensions 235/45R 17 94 W

2) Dual designation 235/45 ZR 17 94 Y

3) Not in conjunction with ESP

4) Tire approval being prepared

Model	Tire designation	Disc wheel designation	Sheet-steel	Light-alloy	Recommended tire makes
	215/55 R 16 93 W	7.5Jx16 H2 ET 41	X	X	CONTINENTAL Eco Contact CP GOODYEAR Eagle Touring NCT 3 MICHELIN MXV 3A Pilot HX PIRELLI P 6000
	235/45 R 17 93W	8Jx17 H2 ET 37		X	CONTINENTAL Conti Sport Contact ¹⁾ DUNLOP SP Sport 9000 ¹⁾ GOODYEAR Eagle F1 MICHELIN MXX 3 Pilot SX ²⁾ PIRELLI P 6000 ²⁾
	235/45 R 17 94 W	8Jx17 H2 ET 37		X	CONTINENTAL Sport Contact ¹⁾ DUNLOP SP Sport 9000 ¹⁾ GOODYEAR Eagle F1 MICHELIN MXX 3 Pilot SX ²⁾ PIRELLI P 6000 ²⁾
as of 01/98	215/55 R 16 93 V	7.5Jx16 H2 ET 41	X	X	CONTINENTAL Eco Contact CP DUNLOP SP Sport 2020 E GOODYEAR Eagle Touring NCT 3 MICHELIN MXV 3A Pilot HX PIRELLI P 6000
210.063	215/55 R 16 93 W	7.5Jx16 H2 ET 41	X	X	CONTINENTAL Eco Contact CP GOODYEAR Eagle Touring NCT 3 MICHELIN MXV 3A Pilot HX PIRELLI P 6000
	235/45 R 17 93 W	8Jx17 H2 ET 37		X	CONTINENTAL Conti Sport Contact ¹⁾ DUNLOP SP Sport 9000 ¹⁾ GOODYEAR Eagle F1 MICHELIN MXX 3 Pilot SX ²⁾ PIRELLI P 6000 ²⁾

1) Approved with dimensions 235/45R 17 94 W

2) Dual designation 235/45 ZR 17 94 Y

3) Not in conjunction with ESP

4) Tire approval being prepared

Model	Tire designation	Disc wheel designation	Sheet-steel	Light-alloy	Recommended tire makes
	235/45 R 17 94 W	8Jx17 H2 ET 37		X	CONTINENTAL Sport Contact ¹⁾ DUNLOP SP Sport 9000 ¹⁾ GOODYEAR Eagle F1 MICHELIN MXX 3 Pilot SX ²⁾ PIRELLI P 6000 ²⁾
as of 01/98	215/55 R 16 93 V	7.5Jx16 H2 ET 41	X	X	CONTINENTAL Eco Contact CP DUNLOP SP Sport 2020 E GOODYEAR Eagle Touring NCT 3 MICHELIN MXV 3A Pilot HX PIRELLI P 6000
210.065	215/55 R 16 93 W	7.5Jx16 H2 ET 41	X	X	CONTINENTAL Eco Contact CP GOODYEAR Eagle Touring NCT 3 MICHELIN MXV 3A Pilot HX PIRELLI P 6000
	235/45 R 17 93 W	8Jx17 H2 ET 37		X	CONTINENTAL Conti Sport Contact ¹⁾ DUNLOP SP Sport 9000 ¹⁾ GOODYEAR Eagle F1 MICHELIN MXX 3 Pilot SX ²⁾ PIRELLI P 6000 ²⁾
	235/45 R 17 94 W	8Jx17 H2 ET 37		X	CONTINENTAL Sport Contact ¹⁾ DUNLOP SP Sport 9000 ¹⁾ GOODYEAR Eagle F1 MICHELIN MXX 3 Pilot SX ²⁾ PIRELLI P 6000 ²⁾
as of 01/98	215/55 R 16 93 V	7.5Jx16 H2 ET 41	X	X	CONTINENTAL Eco Contact CP DUNLOP SP Sport 2020 E GOODYEAR Eagle Touring NCT 3 MICHELIN MXV 3A Pilot HX PIRELLI P 6000

1) Approved with dimensions 235/45R 17 94 W

2) Dual designation 235/45 ZR 17 94 Y

3) Not in conjunction with ESP

4) Tire approval being prepared



Model	Tire designation	Disc wheel designation	Sheet-steel	Light-alloy	Recommended tire makes
Special protection (B4)	215/55 R 16 93 H	7.5Jx16 H2 ET 41		X	CONTINENTAL Eco Contact CP GOODYEAR Eagle Touring NCT 3 MICHELIN MXV 3A Energy PIRELLI P 6000
Special protection (B6)	225/55 R 16 99 H Reinforced	7.5Jx16 H2 ET 38		X	PIRELLI P 6000 DUNLOP SPORT DSST ⁸⁾
Special protection	CT 225/40 R475 102H Reinforced	CT 475x180 ET 34		X	CONTINENTAL CH 52
210.070 up to CY 99/1 (06/99)	215/55 R 16 93 W	7.5Jx16 H2 ET 41		X	CONTINENTAL Eco Contact CP DUNLOP SP Sport 2020 E GOODYEAR Eagle Touring NCT 3 MICHELIN MXV 3A Pilot HX PIRELLI P 6000
up to CY 99/1 (06/99)	235/45 R 17 93 W	8Jx17 H2 ET 37		X	CONTINENTAL Conti Sport Contact ¹⁾ DUNLOP SP Sport 9000 ¹⁾ GOODYEAR Eagle F1 MICHELIN MXX 3 Pilot SX ²⁾ PIRELLI P 6000 ²⁾
up to CY 99/1 (06/99)	235/45 R 17 94 W	8Jx17 H2 ET 37		X	CONTINENTAL Sport Contact ¹⁾ DUNLOP SP Sport 9000 ¹⁾ GOODYEAR Eagle F1 MICHELIN MXX 3 Pilot SX ²⁾ PIRELLI P 6000 ²⁾
as of CY 99/1 (07/99)	235/45 R 17 93 W	7.5Jx17 H2 ET 36		X	CONTINENTAL Conti Sport Contact ¹⁾ DUNLOP SP Sport 9000 ¹⁾ GOODYEAR Eagle F1 MICHELIN MXX 3 Pilot SX ²⁾ PIRELLI P 6000 ²⁾

1) Approved with dimensions 235/45R 17 94 W

2) Dual designation 235/45 ZR 17 94 Y

3) Not in conjunction with ESP

4) Tire approval being prepared



Model	Tire designation	Disc wheel designation	Sheet-steel	Light-alloy	Recommended tire makes
as of CY 99/1 (07/99)	235/45 R 17 94 W	7.5Jx17 H2 ET 37		X	CONTINENTAL Conti Sport Contact ¹⁾ DUNLOP SP Sport 9000 ¹⁾ GOODYEAR Eagle F1
as of CY 99/1 (07/99)	235/45 R 17 94 W	8Jx17 H2 ET 37		X	MICHELIN MXX 3 Pilot SX ²⁾ PIRELLI P 6000 ²⁾
Special protection (B4)	215/55 R 16 93 H	7.5Jx16 H2 ET 41		X	CONTINENTAL Eco Contact CP GOODYEAR Eagle Touring NCT 3 MICHELIN MXV 3A Energy PIRELLI P 6000
Special protection (B6)	225/55 R 16 99 H Reinforced	7.5Jx16 H2 ET 38		X	PIRELLI P 6000 DUNLOP SPORT DSST ⁸⁾
Special protection	CT 225/40 R475 102H Reinforced	CT 475x180 ET 34		X	CONTINENTAL CH 52
210.072	215/55 R 16 93 W	7.5Jx16 H2 ET 41		X	CONTINENTAL Eco Contact CP GOODYEAR Eagle Touring NCT 3 MICHELIN MXV 3A Pilot HX PIRELLI P 6000
	235/45 R 17 93 W	8Jx17 H2 ET 37		X	CONTINENTAL Conti Sport Contact ¹⁾ DUNLOP SP Sport 9000 ¹⁾ GOODYEAR Eagle F1 MICHELIN MXX 3 Pilot SX ²⁾ PIRELLI P 6000 ²⁾
Special protection	225/55 R 16 99 H Reinforced	7.5Jx16 H2 ET 38		X	PIRELLI P 6000
Special protection	CT 225/40 R475 102H Reinforced	CT 475x180 ET 34		X	CONTINENTAL CH 52

1) Approved with dimensions 235/45R 17 94 W

2) Dual designation 235/45 ZR 17 94 Y

3) Not in conjunction with ESP

4) Tire approval being prepared

Model	Tire designation	Disc wheel designation	Sheet-steel	Light-alloy	Recommended tire makes
210.081/082	215/55 R 16 93 W	7.5Jx16 H2 ET 41		X	CONTINENTAL Eco Contact CP GOODYEAR Eagle Touring NCT 3 MICHELIN MXV 3A Pilot HX PIRELLI P 6000
	235/45 R 17 93 W	8Jx17 H2 ET 37		X	CONTINENTAL Conti Sport Contact ¹⁾ DUNLOP SP Sport 9000 ¹⁾ GOODYEAR Eagle F1 MICHELIN MXX 3 Pilot SX ²⁾ PIRELLI P 6000 ²⁾
	235/45 R 17 94 W	8Jx17 H2 ET 37		X	CONTINENTAL Sport Contact ¹⁾ DUNLOP SP Sport 9000 ¹⁾ GOODYEAR Eagle F1 MICHELIN MXX 3 Pilot SX ²⁾ PIRELLI P 6000 ²⁾
as of 01/98	215/55 R 16 93 V	7.5Jx16 H2 ET 41	X	X	CONTINENTAL Eco Contact CP DUNLOP SP Sport 2020 E GOODYEAR Eagle Touring NCT 3 MICHELIN MXV 3A Pilot HX PIRELLI P 6000
210.083	235/45 R 17 93 W	7.5Jx17 H2 ET 36		X	CONTINENTAL Conti Sport Contact ¹⁾ DUNLOP SP Sport 9000 ¹⁾ GOODYEAR Eagle F1 MICHELIN MXX 3 Pilot SX ²⁾ PIRELLI P 6000 ²⁾
	235/45 R 17 94 W	7.5Jx17 H2 ET 37		X	CONTINENTAL Sport Contact ¹⁾ DUNLOP SP Sport 9000 ¹⁾ GOODYEAR Eagle F1

1) Approved with dimensions 235/45R 17 94 W

2) Dual designation 235/45 ZR 17 94 Y

3) Not in conjunction with ESP

4) Tire approval being prepared

Model	Tire designation	Disc wheel designation	Sheet-steel	Light-alloy	Recommended tire makes
	235/45 R 17 93 W	8Jx17 H2 ET 37		X	CONTINENTAL Conti Sport Contact ¹⁾ DUNLOP SP Sport 9000 ¹⁾ GOODYEAR Eagle F1 MICHELIN MXX 3 Pilot SX ²⁾ PIRELLI P 6000 ²⁾
	235/45 R 17 94 W	8Jx17 H2 ET 37		X	MICHELIN MXX 3 Pilot SX ²⁾ PIRELLI P 6000 ²⁾
210.206/210 /215/216 /217	205/65 R 15 94 H	7Jx15 H2 ET 37	X	X	GOODYEAR Eagle Touring NCT 3 MICHELIN MXV 3A Energy
	205/65 R 15 94 V	7Jx15 H2 ET 37	X	X	MICHELIN MXV 3A Pilot HX
	215/55 R 16 93 H	7.5Jx16 H2 ET 41	X	X	GOODYEAR Eagle Touring NCT 3 MICHELIN MXV 3A Energy
	215/55 R 16 93 V	7.5Jx16 H2 ET 41	X	X	GOODYEAR Eagle Touring NCT 3 MICHELIN MXV 3A Pilot HX
	215/55 R 16 93 W	7.5Jx16 H2 ET 41	X	X	GOODYEAR Eagle Touring NCT 3 MICHELIN MXV 3A Pilot HX
	235/45 R 17 93 W	8Jx17 H2 ET 37		X	MICHELIN MXX 3 Pilot SX ²⁾ CONTINENTAL Conti Sport Contact ⁴⁾
	210.225/226	215/55 R 16 93 W	7.5Jx16 H2 ET 41	X	X
235/45 R 17 93 W		8Jx17 H2 ET 37		X	MICHELIN MXX 3 Pilot SX ²⁾ CONTINENTAL Conti Sport Contact ⁴⁾
210.235/237	205/65 R 15 94 H	7Jx15 H2 ET 37	X	X	GOODYEAR Eagle Touring NCT 3 MICHELIN MXV 3A Energy
	205/65 R 15 94 V	7Jx15 H2 ET 37	X	X	MICHELIN MXV 3A Pilot HX

1) Approved with dimensions 235/45R 17 94 W

2) Dual designation 235/45 ZR 17 94 Y

3) Not in conjunction with ESP

4) Tire approval being prepared

Model	Tire designation	Disc wheel designation	Sheet-steel	Light-alloy	Recommended tire makes
	215/55 R 16 93 H	7.5Jx16 H2 ET 41	X	X	GOODYEAR Eagle Touring NCT 3 MICHELIN MXV 3A Energy
	215/55 R 16 93 V	7.5Jx16 H2 ET 41	X	X	GOODYEAR Eagle Touring NCT 3 MICHELIN MXV 3A Pilot HX
	215/55 R 16 93 W	7.5Jx16 H2 ET 41	X	X	GOODYEAR Eagle Touring NCT 3 MICHELIN MXV 3A Pilot HX
	235/45 R 17 93 W	8Jx17 H2 ET 37		X	MICHELIN MXX 3 Pilot SX ²⁾ CONTINENTAL Conti Sport Contact ⁴⁾
210.245	215/55 R 16 93 W	7.5Jx16 H2 ET 41	X	X	GOODYEAR Eagle Touring NCT 3 MICHELIN MXV 3A Energy
	235/45 R 17 93 W	8Jx17 H2 ET 37		X	MICHELIN MXX 3 Pilot SX ²⁾ CONTINENTAL Conti Sport Contact ⁴⁾
210.248	205/65 R 15 94 V	7Jx15 H2 ET 37			MICHELIN MXV 3A Pilot HX
	215/55 R 16 93 W	7.5Jx16 H2 ET 41	X	X	GOODYEAR Eagle Touring NCT 3 MICHELIN MXV 3A Energy
	235/45 R 17 93 W	8Jx17 H2 ET 37		X	MICHELIN MXX 3 Pilot SX ²⁾ CONTINENTAL Conti Sport Contact ⁴⁾
210.261	205/65 R 15 94 V ³⁾	7Jx15 H2 ET 37	X	X	MICHELIN MXV 3A Energy
	215/55 R 16 93 W	7.5Jx16 H2 ET 41	X	X	GOODYEAR Eagle Touring NCT 3 MICHELIN MXV 3A Energy
	235/45 R 17 93 W	8Jx17 H2 ET 37		X	MICHELIN MXX 3 Pilot SX ²⁾ CONTINENTAL Conti Sport Contact ⁴⁾
210.263/265	215/55 R 16 93 W	7.5Jx16 H2 ET 41	X	X	GOODYEAR Eagle Touring NCT 3 MICHELIN MXV 3A Energy
	235/45 R 17 93 W	8Jx17 H2 ET 37		X	MICHELIN MXX 3 Pilot SX ²⁾ CONTINENTAL Conti Sport Contact ⁴⁾

1) Approved with dimensions 235/45R 17 94 W

2) Dual designation 235/45 ZR 17 94 Y

3) Not in conjunction with ESP

4) Tire approval being prepared

Model	Tire designation	Disc wheel designation	Sheet-steel	Light-alloy	Recommended tire makes
	235/45 R 17 94 W	8Jx17 H2 ET 37		X	CONTINENTAL Sport Contact ¹⁾ MICHELIN MXX 3 Pilot SX ²⁾
210.270/272	215/55 R 16 93 W	7.5Jx16 H2 ET 41		X	GOODYEAR Eagle Touring NCT 3 MICHELIN MXV 3A Energy
as of CY 99/1 (07/99)	235/45 R 17 94 W	7.5Jx17 H2 ET 37		X	CONTINENTAL Sport Contact ¹⁾ MICHELIN MXX 3 Pilot SX ²⁾
	235/45 R 17 93 W	8Jx17 H2 ET 37		X	MICHELIN MXX 3 Pilot SX ²⁾ CONTINENTAL Conti Sport Contact ⁴⁾
	235/45 R 17 94 W	8Jx17 H2 ET 37		X	CONTINENTAL Sport Contact ¹⁾ MICHELIN MXX 3 Pilot SX ²⁾
as of CY 99/1 (07/99)	235/45 R 17 93W	7.5Jx17 H2 ET 36		X	MICHELIN MXX 3 Pilot SX ²⁾ CONTINENTAL Conti Sport Contact ⁴⁾
as of CY 99/1 (07/99)	225/55 R 16 99 H Reinforced	7.5Jx16 H2 ET 38			PIRELLI P 6000
210.281/282	215/55 R 16 93 W	7.5Jx16 H2 ET 41	X	X	GOODYEAR Eagle Touring NCT 3 MICHELIN MXV 3A Energy
	235/45 R 17 93 W	8Jx17 H2 ET 37		X	MICHELIN MXX 3 Pilot SX ²⁾ CONTINENTAL Conti Sport Contact ⁴⁾
	235/45 R 17 94 W	8Jx17 H2 ET 37		X	CONTINENTAL Sport Contact ¹⁾ MICHELIN MXX 3 Pilot SX ²⁾
210.283	235/45 R 17 93W	7.5Jx17 H2 ET 36			MICHELIN MXX 3 Pilot SX ²⁾ CONTINENTAL Conti Sport Contact ⁴⁾
as of CY 99/1 (07/99)	235/45 R 17 94 W	7.5Jx17 H2 ET 37		X	CONTINENTAL Sport Contact ¹⁾ MICHELIN MXX 3 Pilot SX ²⁾
	235/45 R 17 93W	8Jx17 H2 ET 37		X	MICHELIN MXX 3 Pilot SX ²⁾ CONTINENTAL Conti Sport Contact ⁴⁾

1) Approved with dimensions 235/45R 17 94 W

2) Dual designation 235/45 ZR 17 94 Y

3) Not in conjunction with ESP

4) Tire approval being prepared



Model	Tire designation	Disc wheel designation	Sheet-steel	Light-alloy	Recommended tire makes
	235/45 R 17 94 W	8Jx17 H2 ET 37		X	CONTINENTAL Sport Contact ¹⁾ MICHELIN MXX 3 Pilot SX ²⁾
210.606/610 /616/617 /663	225/55 R 16 99 H Reinforced	7.5Jx16 H2 ET 38	X	X	PIRELLI P 6000

1) Approved with dimensions 235/45R 17 94 W

2) Dual designation 235/45 ZR 17 94 Y

3) Not in conjunction with ESP

4) Tire approval being prepared



D10	GF40.10-P-1050-02FM	Survey of summer tires/disk wheels/recommended tire makes	Model 210 with code 990 AMG vehicles	GF
------------	---------------------	---	--------------------------------------	-----------

Model	Tire designation	Disc wheel designation	Sheet-steel	Light-alloy	Recommended tire makes
AMG 210.0 except E420, E430, E50, E55	225/45 ZR 17	7,5Jx17 H2 ET 35		X	CONTINENTAL Conti Sport Contact MICHELIN MXX 3 Pilot SX DUNLOP SP Sport 8000 MFS BRIDGESTONE Expedia S-01 ²⁾
AMG 210.0 except E50, E55	235/40 ZR 18	8Jx18 H2 ET 31			BRIDGESTONE S-02 DUNLOP SP Sport 8000 MFS MICHELIN MXX 3 Pilot SX
AMG 210 except E50, E55	235/45 ZR 17	7,5Jx17 H2 ET 35		X	MICHELIN MXX 3 Pilot SX BRIDGESTONE Expedia S-01 DUNLOP SP Sport 8000 MFS CONTINENTAL Conti Sport Contact
AMG 210 except E50, E55	FA: 235/40 ZR 18 RA: 265/35 ZR 18	FA: 8Jx18 H2 ET 31 RA: 9Jx18 H2 ET 35		X X	DUNLOP SP Sport 8000 MFS MICHELIN MXX 3 Pilot SX BRIDGESTONE S-02
AMG 210 E50, E55	FA: 235/40 ZR 18 RA: 265/35 ZR 18	FA: 8Jx18 H2 ET 31 RA: 9Jx18 H2 ET 35		X X	MICHELIN MXX 3 Pilot SX

² Also permissible: 225/45 ZR 17 93W



E10	GF40.10-P-1050-02P	Survey of summer tires/disk wheels/recommended tire makes	Model 220	GF
------------	--------------------	---	-----------	----

Model	Tire designation	Disk wheel designation	Sheet-steel	Light-alloy	Recommended tire makes
220.026/063 /065	225/60 R 16 98 V	7,5 J x 16 H2 ET 46		X	CONTINENTAL Eco Contact CP DUNLOP SP Sport 2000 GOODYEAR Eagle Touring NCT 3 MICHELIN MXM Pilot HX PIRELLI P6000 Mark1
	225/60 R 16 98 W	7,5 J x 16 H2 ET 46		X	CONTINENTAL Eco Contact CP DUNLOP SP Sport 2000 GOODYEAR Eagle Touring NCT 3 MICHELIN MXM Pilot HX PIRELLI P6000 Mark1
	225/55 R 17 97 W	7,5 J x 17 H2 ET 46		X	DUNLOP SP Sport 2020 E GOODYEAR Eagle Touring NCT 3 MICHELIN MXM G1 Pilot HX
	245/45 R 18 96 Y	8 J x 18 H2 ET 44		X	PIRELLI P6000 DUNLOP SP Sport 9000 MICHELIN Pilot Sport
220.070/075	225/60 R 16 98 W	7,5 J x 16 H2 ET 46		X	CONTINENTAL Eco Contact CP DUNLOP SP Sport 2000 GOODYEAR Eagle Touring NCT 3 MICHELIN MXM Pilot HX PIRELLI P6000 Mark1
	225/55 R 17 97 W	7,5 J x 17 H2 ET 46		X	DUNLOP SP Sport 2020 E GOODYEAR Eagle Touring NCT 3 MICHELIN MXM G1 Pilot HX



Model	Tire designation	Disk wheel designation	Sheet-steel	Light-alloy	Recommended tire makes
	245/45 R 18 96 Y	8 J x 18 H2 ET 44		X	PIRELLI P6000 DUNLOP SP Sport 9000 MICHELIN Pilot Sport
220.165	225/60 R 16 98 V	7,5 J x 16 H2 ET 46		X	CONTINENTAL Eco Contact CP DUNLOP SP Sport 2000 GOODYEAR Eagle Touring NCT 3 MICHELIN MXM Pilot HX PIRELLI P6000 Mark1
	225/60 R 16 98 W	7,5 J x 16 H2 ET 46		X	CONTINENTAL Eco Contact CP DUNLOP SP Sport 2020E GOODYEAR Eagle Touring NCT 3 MICHELIN MXM Pilot HX PIRELLI P6000 Mark1
	225/55 R 17 97 W	7,5 J x 17 H2 ET 46		X	DUNLOP SP Sport 2020 E GOODYEAR Eagle Touring NCT 3 MICHELIN MXM G1 Pilot HX
	245/45 R 18 96 Y	8 J x 18 H2 ET 44		X	PIRELLI P6000 DUNLOP SP Sport 9000 MICHELIN Pilot Sport
220.170/175	225/60 R 16 98 W	7,5 J x 16 H2 ET 46		X	CONTINENTAL Eco Contact CP DUNLOP SP Sport 2000 GOODYEAR Eagle Touring NCT 3 MICHELIN MXM Pilot HX PIRELLI P6000 Mark1
	225/55 R 17 97 W	7,5 J x 17 H2 ET 46		X	DUNLOP SP Sport 2020 E GOODYEAR Eagle Touring NCT 3 MICHELIN MXM G1 Pilot HX
	245/45 R 18 96 Y	8 J x 18 H2 ET 44		X	PIRELLI P6000 DUNLOP SP Sport 9000 MICHELIN Pilot Sport



Model	Tire designation	Disk wheel designation	Sheet-steel	Light-alloy	Recommended tire makes
220.178	245/45 R 18 96 Y	8 J x 18 H2 ET 44		X	PIRELLI P6000 DUNLOP SP Sport 9000 MICHELIN Pilot Sport
220.175/178S pecial protection	235-700 R 450 PAX	235-700 PAV 54		X	MICHELIN XSE

Spare wheel

Model	Tire designation	Disk wheel designation	Sheet-steel	Light-alloy	Recommended tire makes
220.026/063 /065/070 /075/165 /170/175	225/60 R 16 98 W	7,5 J x 16 H2 ET 51		X	CONTINENTAL Eco Contact CP DUNLOP SP Sport 2000 E GOODYEAR Eagle Touring NCT 3 MICHELIN MXM Pilot HX PIRELLI P6000 Mark1
	225/55 R 17 97 W	7,5 J x 17 H2 ET 51		X	DUNLOP SP Sport 2020 E GOODYEAR Eagle Touring NCT 3

**Light-weight design spare wheel**

Every vehicle is equipped with a minimum weight light-weight design spare wheel and full-size tire.

This wheel is designed for a limited life of a maximum of 20 000 km and should **not** be used as a normal wheel.

When replacing tires, the spare tire can be fitted to a wheel if the tire is of the same design as the wheels.



J10	GF40.10-P-1050-02PM	Survey of summer tires/disk wheels/recommended tire makes	Model 220 with code 990 AMG vehicles	 GF
------------	---------------------	---	--------------------------------------	---

Model	Tire designation	Disk wheel designation	Sheet-steel	Light-alloy	Recommended tire makes
AMG 220	245/45 R 18 96Y	8.5Jx18 ET 44		X	BRIDGESTONE CONTINENTAL DUNLOP MICHELIN PIRELLI
Not with code 487	FA: 245/45 R 18 96Y RA: 275/40 R 18 99 Y MO	FA: 8.5Jx18 ET 44 RA: 9.5Jx18 ET 46		X X	BRIDGESTONE CONTINENTAL DUNLOP MICHELIN PIRELLI

K10 AN40.10-P-1050-01A	Retrofit conversion to Mercedes-Benz 8-hole 7 J x 16 H2 ET46 light-alloy disc wheel with 215/55 R 16 tire	Model 124	
----------------------------------	---	-----------	--

The 16" wheel/tire combination familiar from model 124.034 (E420) as of vehicle ident. no. - B- 938 869 is approved for the retrofit conversion for model 124, except for:

- vehicles with special body
- saloons with long wheelbase
- 4MATIC
- coupés up to vehicle ident. no. - B - 065 820
- Model 124.036 (E500)

A condition for the use of this wheel/tire combination is that the work described in Sections A and B is completed in full.

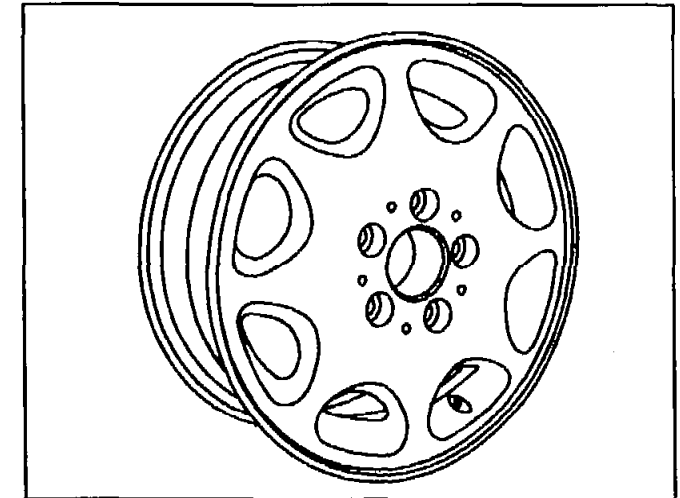

P40.10-0240-01

A. Changes to the body

The inner edges of the fenders of the front wings must be flanged over through an angle of 110°,

- On vehicles up to 08/89 in the entire wheel cutout (not illustrated)

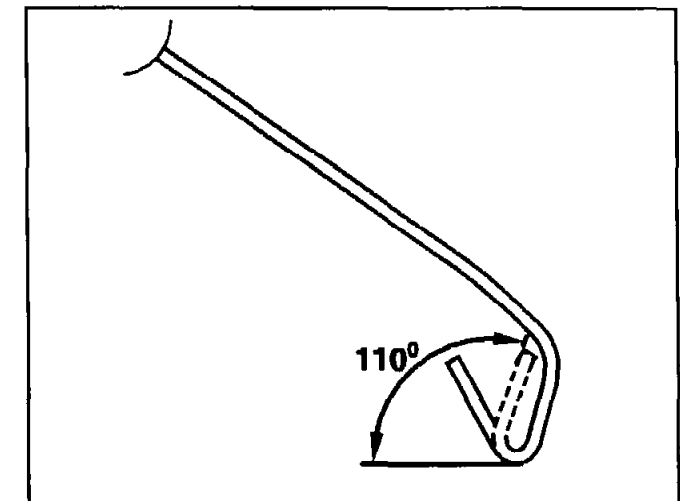

P40.10-0239-01

- On vehicles as of 09/89 in the marked area (A).

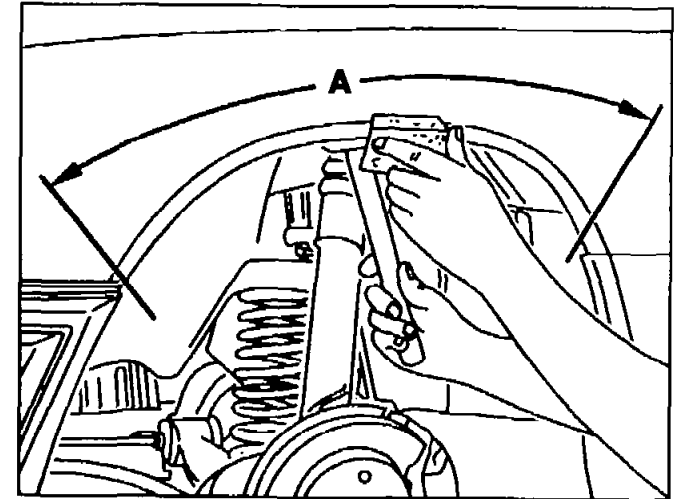

P40.10-0237-01

B. Assembly of side moldings

The side moldings (arrow) on the front fenders are to be replaced by the moldings from model 124.034 on vehicles as of 09.89 (specify color number).

Note

Side moldings which are not available in the required color are to be repainted to match the vehicle.

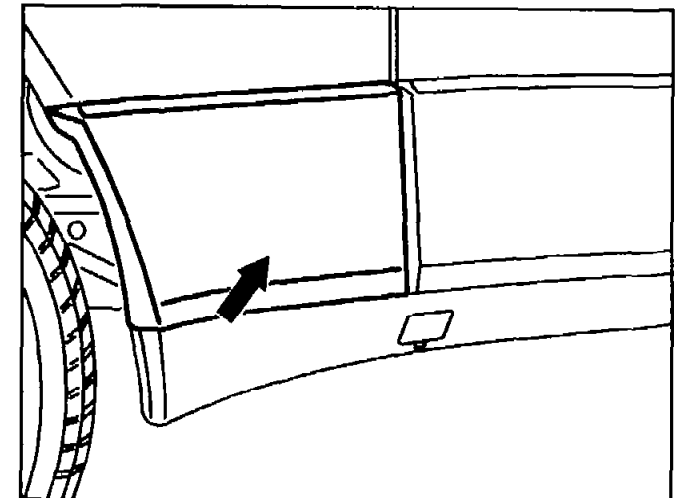

P40.10-0238-01

**C. Note on chassis adjustment**

Adjust vehicle-specific caster at the front axle to positive tolerance.

D. Tire inflation pressure/tire makes/using snow chains

- a) The tire inflation pressure in accordance with the adhesive plate in the tank flap remains valid.
- b) The recommended tire makes can be obtained from the relevant Service Information.
- c) Snow chains can only be used with standard production tires.

E. Regulations governing registration

In the Federal Republic of Germany, the vehicle must be passed by a technical automotive inspection agency and a note to this effect must be entered in the vehicle documents. This notification and a Mercedes-Benz certificate (apply to Mr. Breitbarth VP/SGS, facsimile no. 40101) must be submitted to the vehicle licensing center.

In other countries the laws and regulations of the country in question are to be complied with.



N10 AN40.10-P-1050-02A	Retrofit conversion to Mercedes-Benz 5-hole 8« J x 16 H2 ET47 light-alloy disc wheel with 255/45 R 18 tire	Model 140 (except (AUS) (J) (USA) and special protection vehicles)	
-------------------------------	--	--	--

The model 140.063/07 (coupé) 18" wheel/tire combination as of vehicle ident. no. -A-192 209 is approved for all saloons and coupés.

A condition for the use of this wheel/tire combination is that the work described in Sections A and B is completed in full.

Regulations governing registration

In the Federal Republic of Germany, the vehicle must be passed by a technical automotive inspection agency and a note to this effect must be entered in the vehicle documents. This notification and a Mercedes-Benz certificate (apply to Mr. Breitbarth VP/SGS, facsimile no. 40101) must be submitted to the vehicle licensing center.

In other countries the laws and regulations of the country in question are to be complied with.

Note

Phased in as of 06/93, the 18" tires are listed as an alternative in the vehicle documents (sec. 33 of art. 20 to 23) in addition to the 16" tires. Check the vehicle documents accordingly.

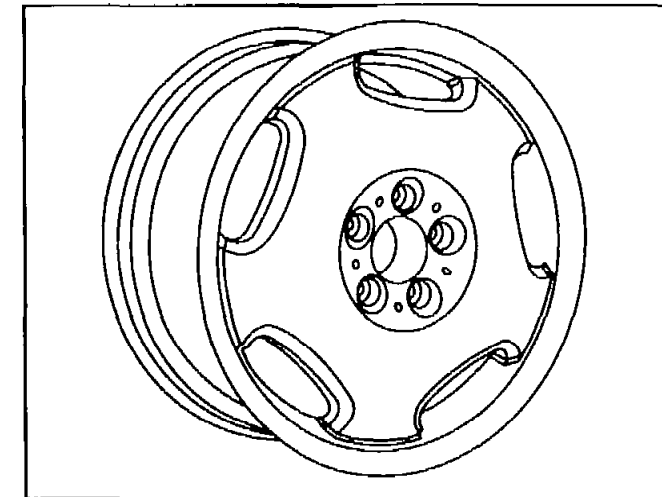

P40.10-0236-01

**A. Changes to the body (coupés only)**

Raise the inner edges of the front fender in the area marked (A) by min. 10° (corresponds to a flange width of 18 mm).

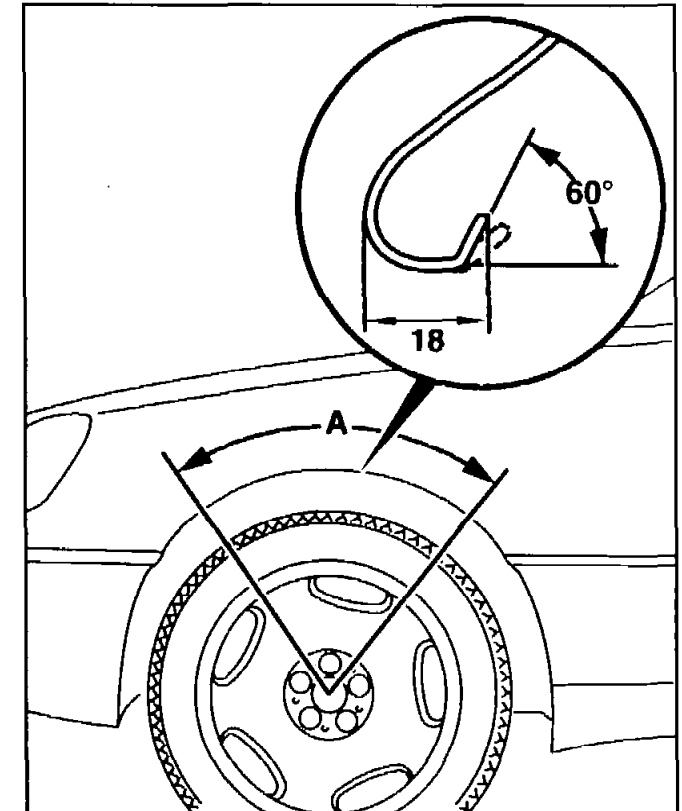

P40.10-0247-02

**B. Installation of spacers (saloons and coupés)**

Install bracket (43h or 43i) for wheelhouse lining.

Arrangement of left/right bracket (43h)

(side molding dismantled)

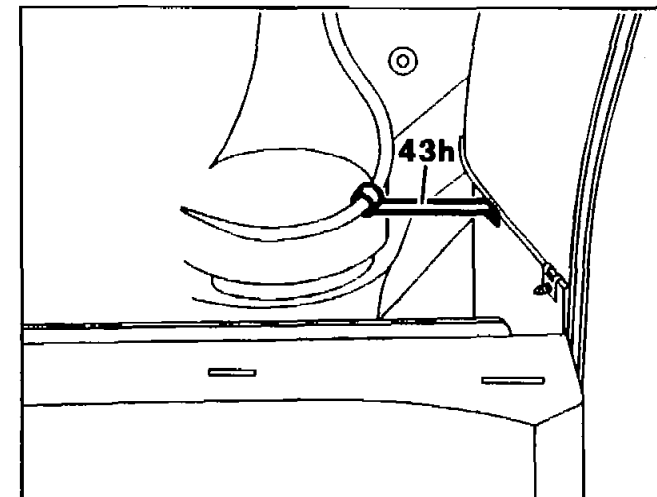

P40.10-0234-01

Arrangement of right bracket (43i) on vehicles with auxiliary heater

(side molding dismantled)

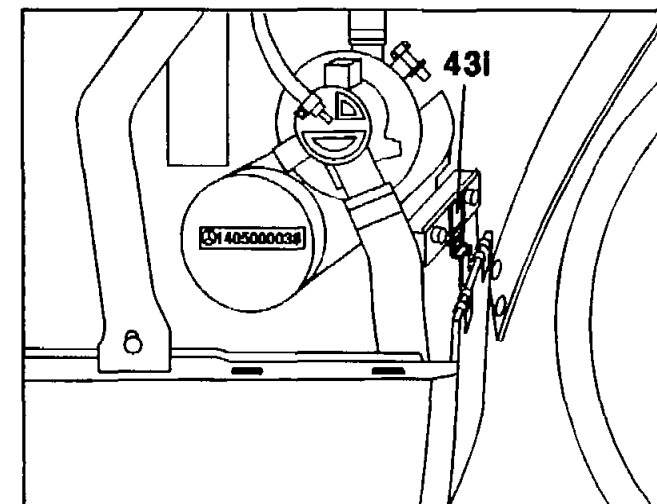

P40.10-0233-01

C. Tire inflation pressure/tire makes/snow chains/wheel bolts

- The tire inflation pressure in accordance with the adhesive plate in the tank flap remains valid.
- The recommended tire makes can be obtained from the relevant Service Information.
- Snow chains can only be used with 16" tires without any restrictions.
- The necessary wheel bolts must be included with a 16" sheet-steel spare wheel.

D. Notes on the use of the 16" spare wheel

(A copy of these notes should be handed to the owner for insertion into his Owner's Manual)

Fitting the 16" spare wheel

If your spare wheel is made of sheet steel, only use the wheel bolts included with the wheel.

The spare wheel should only be used for short distances, as the handling characteristics of the vehicle may be impaired by the different wheel/tire combinations. We recommend that you adapt your driving style to this situation.

Spare wheel on the front axle: To prevent overheating of the brake system on mountainous descents, only use selector lever position "2" or "3", or with a manual transmission only 2nd or 3rd gear.

Mercedes-Benz AG

Vertrieb Personenwagen