

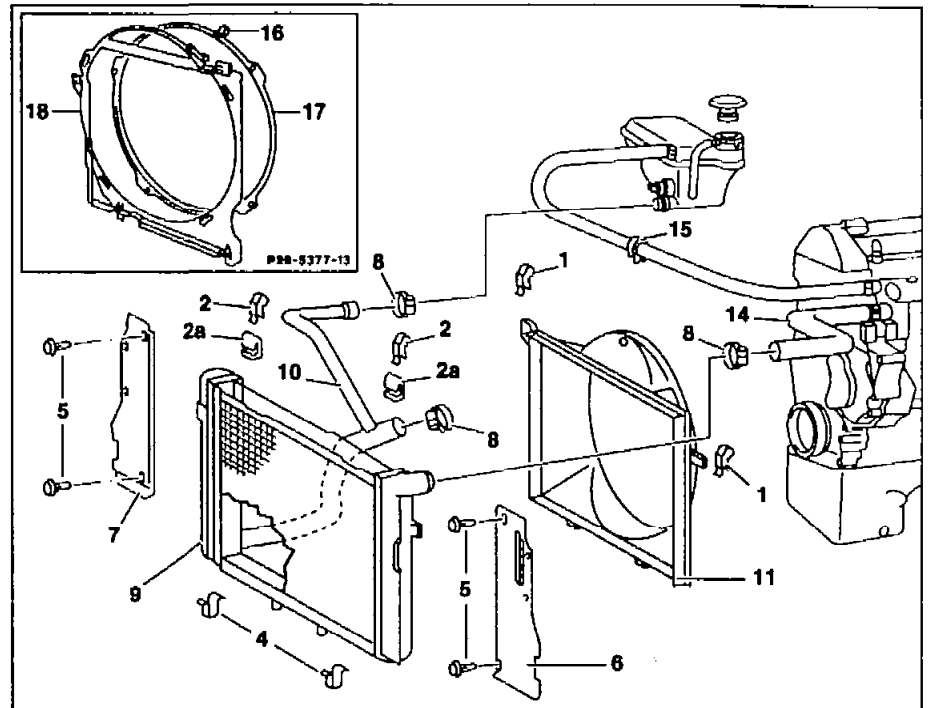









ENGINE 601 in MODEL 124, 201  
 ENGINE 602 in MODEL 124, 201  
 ENGINE 603 in MODEL 124, 126, 140



P20.20-0269-06

 	Removing, installing		
1	Remove bottom engine compartment panel		
2	Drain coolant		20-010
3.1	Unbolt oil lines at radiator, pinch off	 only models with automatic transmission 	000 589 40 37 00
4	Unclip holder (15) for vent hose		
5	Pull out flat spring (1)		
6	Take off fan shroud (11) and place over the fan		
7	Detach coolant hoses (10, 14)	 	WH58.30-Z-1001-06A WH58.30-Z-1002-06A
8	Take out expanding rivets (5)		
9	Remove radiator panel (6, 7)		
10	Pull off retaining clip (4)		
11.1	Unbolt front end crossmember	 Model 140 and 201.128	
12	Detach hood cable		
13.1	Take off front bumper	 Model 201.128 with AC	
14	Unbolt condenser from radiator		
15	Pull out flat spring (2)		
16	Lift out radiator (9)	 Installation model 140: With new radiator ↓	



		Align radiator to front end crossmember	AR20.20-P-3865-02A
17	Install in the reverse order		
18	Inspect cooling system for leaks		AR20.00-P-1010HA AR20.00-P-1010HA

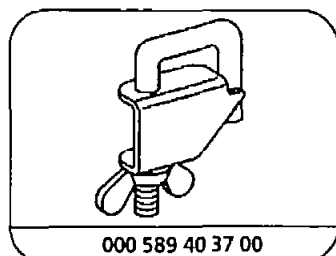

Clamp

#### Commercially available tools

Number	Designation	Make (e.g.)	Order number
WH58.30-Z-1001-06A	6 mm wrench hexagon and flexible shaft for hose clips with worm drive	Hazet Güldenwerther Bahnhofstraße 25-28 D-42857 Remscheid	426-6
WH58.30-Z-1002-06A	7 mm wrench hexagon and flexible shaft for hose clips with worm drive	Hazet Güldenwerther Bahnhofstraße 25-28 D-42857 Remscheid	426-7