









ENGINE 111, 112, 113, 120, 601, 602 /, 603, 604, 605, 606 /, 611

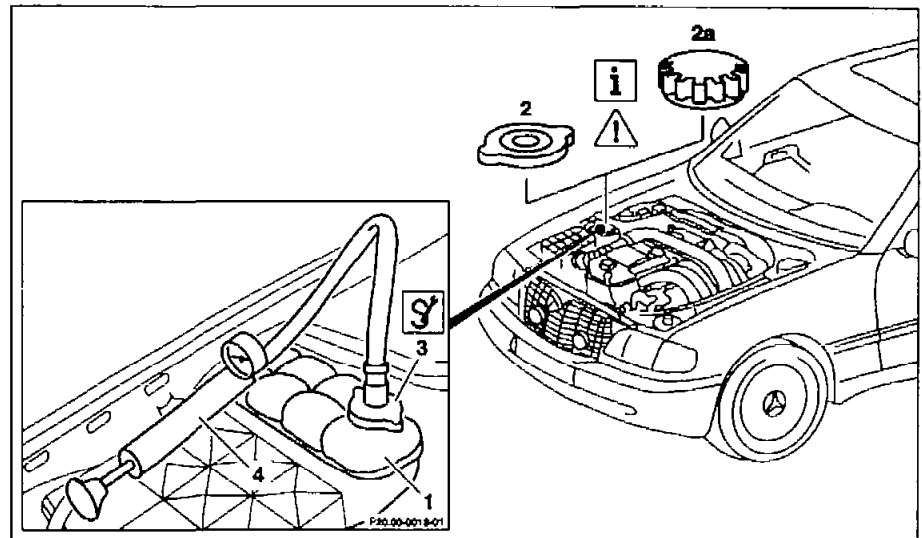





- 1 Expansion reservoir  
 2 Cooling system cap with detent  
 2a 2-stage cooling system cap  
 3  Test cap  
 4  Tester



P20.00-0397-05

	Removing, installing		
 <b>Danger!</b>	Risk of injury to skin and eyes from scalding from hot coolant which splashes out. Risk of poisoning from swallowing coolant.	Do not open the cooling system unless the coolant temperature is below 90 °C. Open cap slowly and allow the pressure to release. Do not pour coolant into containers for drinks. Wear protective gloves, protective clothes, and eye protection.	AS20.00-Z-0001-01A AR20.00-P-1010HA/3
1	Open cap of expansion reservoir or radiator (2, 2a)	- Cooling system cap with detent (2): Carefully turn cap to the first detent, release pressure, and then unscrew cap - 2-stage cooling system cap (2a) or cap in model 163: Turn cap half a turn anti-clockwise, release pressure, and then unscrew cap	
2.1	Set heater switches to maximum heating capacity	All except model 163  Model 163 has no clocked valves, the coolant flows through the heating system heat exchanger permanently	
	Testing		
3	Check coolant level, adjust if necessary	Engine 111  Model 463, 220, 210, 208, 202, 129 with engine 112, 113  Model 163 with engine 112, 113	AH20.00-P-1142-01A AR20.00-P-1010HA/3  AH20.00-P-1142-01V AR20.00-P-1010HA/5  AH20.00-P-1142-01GH AR20.00-P-1010HA/7
4	Install test cap (3) at the expansion reservoir or radiator	 Test cap for cooling system cap with detent (2)  Test cap for 2-position cooling system cap	124 589 00 91 00  210 589 00 91 00



		 Test cap for model 163 with engine 112, 113	163 589 01 91 00
5	Connect tester		124 589 24 21 00
6	Test cooling system for leaks	 Test pressure approx. 1.4 bar.  If cylinder head gaskets are new, first of all bring engine to operating temperature and then test cooling system for leaks	
7	Inspect cooling and heating hoses and also their connection points for proper condition and loss of coolant, replace coolant hoses if necessary		
8	Inspect condition and installation of hose clips, retighten or replace if necessary	 	WH58.30-Z-1001-06A  WH58.30-Z-1002-06A

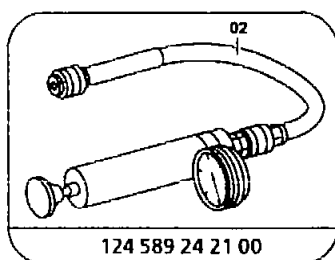

124 589 24 21 00

Tester

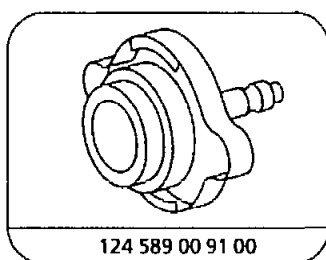

124 589 00 91 00

Test cap

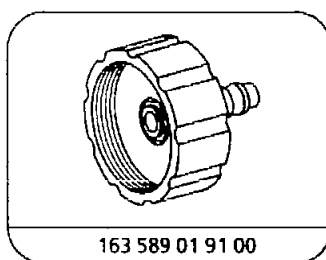

163 589 01 91 00

Test cap

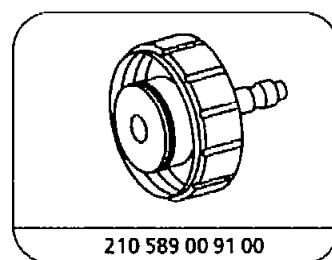

210 589 00 91 00

Test cap

#### Commercially available tools

Number	Designation	Make (e.g.)	Order number
WH58.30-Z-1001-06A	6 mm wrench hexagon on flexible shaft for hose clips with worm drive	Hazet Güldenwerther Bahnhofstraße 25-28 D-42857 Remscheid	426-6
WH58.30-Z-1002-06A	7 mm wrench hexagon on flexible shaft for hose clips with worm drive	Hazet Güldenwerther Bahnhofstraße 25-28 D-42857 Remscheid	426-7



AS20.00-Z-0001-01A	Risk of injury to skin and eyes from scalding from hot coolant which splashes out..Risk of poisoning from swallowing coolant.	Do not open the cooling system unless the coolant temperature is below 90 °C. Open cap slowly and allow the pressure to release. Do not pour coolant into containers for drinks. Wear protective gloves, protective clothes, and eye protection.	⚠ Danger!
--------------------	---	--	-----------

**Possible dangers**

**Risk of injury**

The cooling system is pressurized when the engine is warm. Risk of scalding from hot coolant which splashes out if the cooling system is opened suddenly.

**Risk of poisoning**

If coolant is swallowed, the person affected is likely to show signs of poisoning such as headaches, giddiness and stomach aches, paralysis of the respiratory system, unconsciousness, nausea, and convulsions.

**Protective measures/rules of conduct**

- Allow cooling system to cool down to a coolant temperature of less than 90 °C.
- Open coolant system cap slowly; open a conventional type of coolant system cap to the first detent and open a screw-type coolant system cap about 1/2 turn, and allow the pressure to release.
- Wear protective gloves, protective clothes, and eye protection.
- Do not pour coolant into containers for drinks.

**First aid measures**

- Pour large quantities of cold water over the affected area of skin and cover over with sterile bandages.
- Have person affected drink plenty of water to which medicinal carbon has been added.
- Consult a doctor if the person affected has severe burns or has swallowed considerable quantities.

AH20.00-P-1142-01A	Notes on engine coolant level	Model 124, 129, 140, 168, 170, 202, 208, 210, 463	1
--------------------	-------------------------------	---	---

**Model 124:** The coolant level when the engine is cold must extend up to the marking (arrow) on the coolant expansion tank.

When coolant is warm: about 1 cm above this marking.

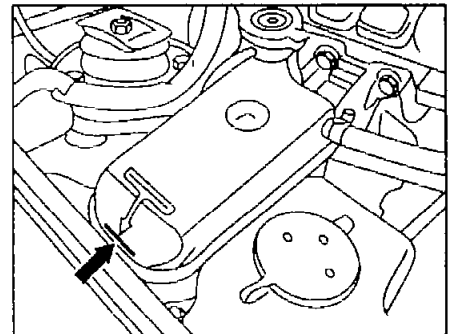

P20.00-0219-01

**Model 129:** The coolant level when the engine is cold must extend up to the marking (arrow) on the coolant expansion tank.

When coolant is warm: about 1 cm above this marking.

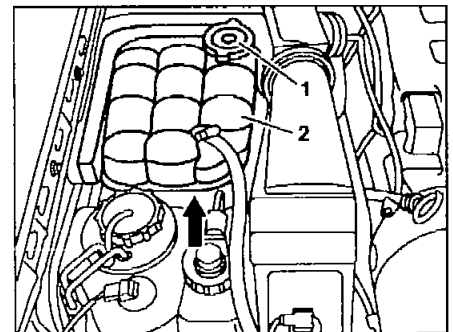

P20.00-0228-01

