

## ENGINE 603.971 in MODEL 140

- 3 Oil drain plug
  - 14 Oil line
  - 15 Oil line
  - 18 Oil level sensor
  - 19 Hexagon bolt
  - 20 Dipstick guide tube with flange and gasket
  - 28 Front engine mount
  - 45 Oil pan
  - 45a Oil pan gasket
- L3 Starter ring gear speed sensor

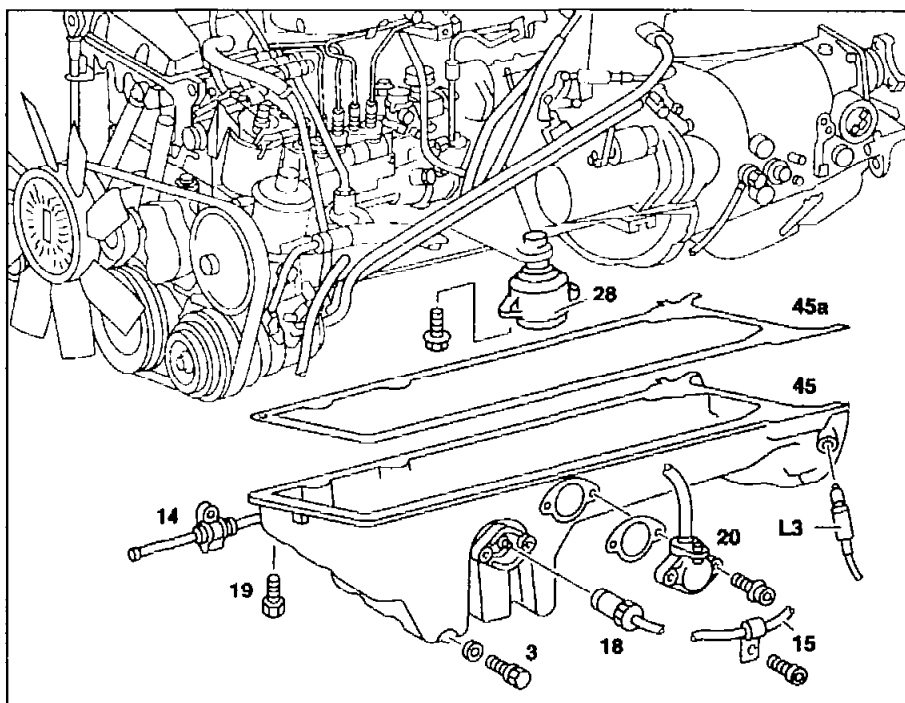

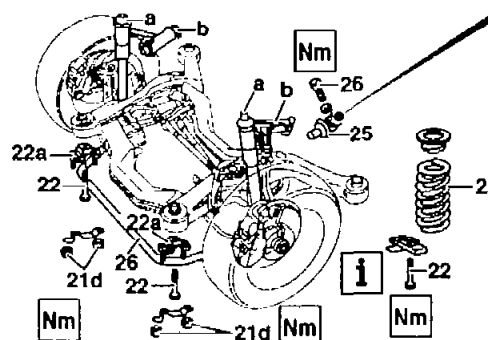

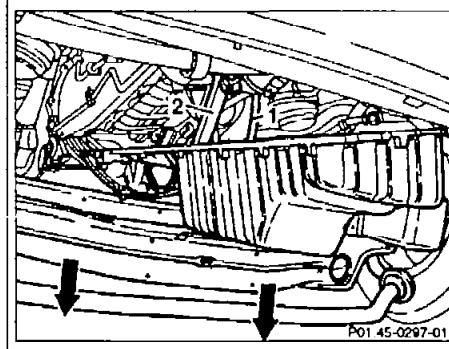
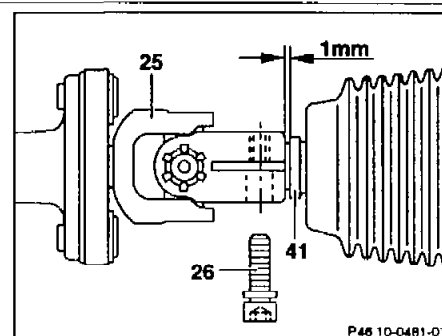
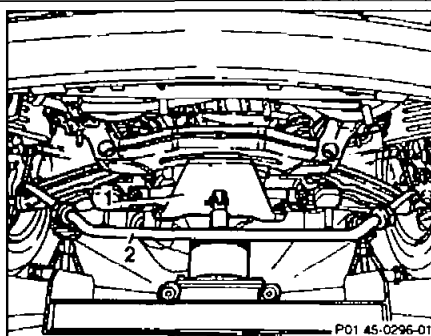
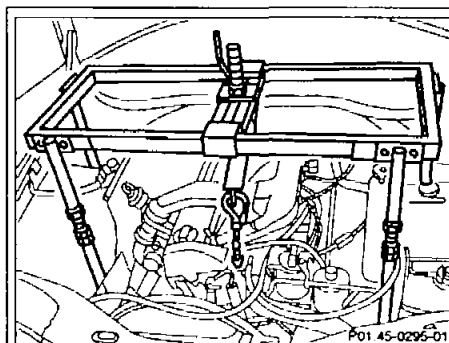













P01.45-0294-06



P01.45-0298-09

	Removing, installing		
1	Disconnect ground cable at battery		AR54.10-P-0003A
2	Drain engine oil		AP18.00-P-0101AA
3	Detach fan shroud, place over fan		
4	Unbolt speed sensor (L3) at oil pan and ground strap		

5	Unplug connector of oil level sensor (18)		
6	Unbolt dipstick guide tube with flange (20)	 Installation: Replace gasket.	
7	Detach oil lines (14, 15) at connection piece to the oil hoses	  Pinch off oil lines before disconnecting.	000 589 40 37 00
8	Unscrew nuts for torsion bar (21d) on both sides	 Installation: Replace nuts.	BA32.20-P-1003-02B
9	Unbolt front left and right engine mounts (28) and raise with engine hoist		AR22.10-P-1260HX
10	Fit on engine supporting frame (01) and raise engine		140 589 01 61 00
11	Remove springs of front suspension		AR32.20-P-0200B
12	Unscrew bolt (31d) for steering play	  Move out steering shaft in straight-ahead position.  Installation: Gap between steering joint and gasket should be 1.0 mm.  	BA46.10-P-1001-01A  BA46.10-P-1002-01A BA46.10-P-1003-01A
13	Support front suspension. Use car jack attachment and unscrew plastic covers above the two rear attachment points		140 589 00 62 00
14	Unscrew bolts of front suspension attachment (22)		AR33.10-P-0100A
15	Lower front suspension	 Lower front suspension only sufficiently as the brake lines permit.	
16	Unscrew hexagon bolts (19) of oil pan (45)	 Pay attention to different lengths of the hexagon bolts.	BA01.45-P-1001-01A
17	Take oil pan (45) together with oil pan gasket (45a) off the crankcase	 Take out oil pan in direction of travel; turn crankshaft slightly for this step, if necessary.  Installation: Clean off gasket residues on contact surfaces of oil pan. Replace oil pan gasket (45a). Align oil pan to rear contact surface on transmission. If the oil pan is not aligned to the transmission, this can result in noise and vibration problems.	
18	Install in the reverse order		
 <b>Danger!</b>	Risk of accident as a result of vehicle starting off when engine running. Risk of injury as a result of bruises and burns if you insert your hands into engine when it is being started or when it is running.	Secure vehicle to prevent it starting off. Wear closed and close-fitting work clothes. Do not grasp hot or rotating parts.	AS00.00-Z-0005-01A <b>AR01.45-P-7500HY/4</b>
19	Warm up engine and inspect for leaks		



**Nm** Oil pan

Number	Designation	Engine 603.913/ 963	
BA01.45-P-1001-01A	Bolt of oil pan to crankcase	M6	Nm 10
		M8	Nm 25
		M10	Nm -

**Nm** Steering shaft

Number	Designation			Model 140 up to vehicle ident end no. A-033 950	Model 40 as of vehicle ident end no. A-033 951 bis A-166 259
BA46.10-P-1001-01A	Hexagon socket bolt of steering joint	M8	Nm	25	-
BA46.10-P-1002-01A	Hexagon socket bolt of steering joint	M10	Nm	-	30
BA46.10-P-1003-01A	Torx bolt of steering joint	M8	Nm	-	-

**Nm** Steering shaft

Number	Designation			Model 140 as of vehicle ident end no. A-166 260
BA46.10-P-1001-01A	Hexagon socket bolt of steering joint	M8	Nm	-
BA46.10-P-1002-01A	Hexagon socket bolt of steering joint	M10	Nm	-
BA46.10-P-1003-01A	Torx bolt of steering joint	M8	Nm	20

**Nm** Front suspension torsion bar

Number	Designation			Model 140 up to 10/95	Model 140 as of 10/95
BA32.20-P-1003-02B	Self-locking nut for catching retaining arm of torsion bar to front suspension carrier	Nm	20	20	20

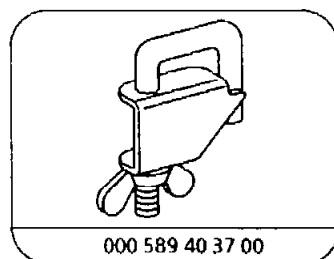

Clamp

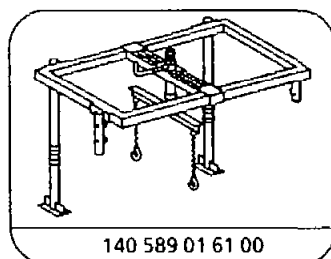

Engine supporting frame

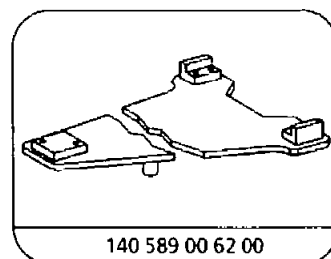

Assembly attachment



AS00.00-Z-0005-01A	Risk of accident as a result of vehicle starting off when engine is running. Risk of injury as a result of bruises and burns if you insert your hands into engine when it is being started or when it is running.	Secure vehicle to prevent it from moving off. Wear closed and close-fitting work clothes. Do not grasp hot or rotating parts.	 <b>Danger!</b>
--------------------	---	---	--

#### Possible dangers

##### Risk of accident

from vehicle starting off during starting operation (e.g. when testing compression pressure) as a result of gear engaged or when engine running and vehicles with automatic transmission as a result of selector lever position "P" or "N" not engaged (exception: some vehicles do not have a selector lever position "P").

##### Risk of injury

Severe injuries may be caused by freely rotating parts in the area of the running engine. The heat produced by the engine when it is operating can result in severe burns if contact is made with individual, unshielded parts.

#### Rules of conduct / Protective measures

- As a general rule, carry out work on the running engine only if this is absolutely essential.
- Before starting the engine, **apply parking brake**.
- On models with manual transmission, **move gearshift lever into Neutral position**.
- On models with automatic transmission, **move selector lever into position "P" or "N"** (exception: some vehicles do not have a selector lever position "P").
- On models which **do not have selector lever position "P"**, **secure selector lever to prevent it from being operated unintentionally**.
- **Wear closed and close-fitting work clothes**.
- **Take off any jewelry, such as chains, rings etc.**
- **If you have long hair, wear a suitable head cover**.
- Before commencing work on the running engine, **check to obtain a general picture of the positioning of parts which may be hot**.
- When carrying out work when starting the engine or when engine is running, **do not touch any hot and rotating parts**.

#### First aid measures in the event of burns

- Do not rub the skin areas affected; flush with plenty of cold water and cover skin with sterile bandages.
- Immediately consult a physician.