

ENGINE 605, 606 in MODEL 124
ENGINE 601, 604, 605 in MODEL 202

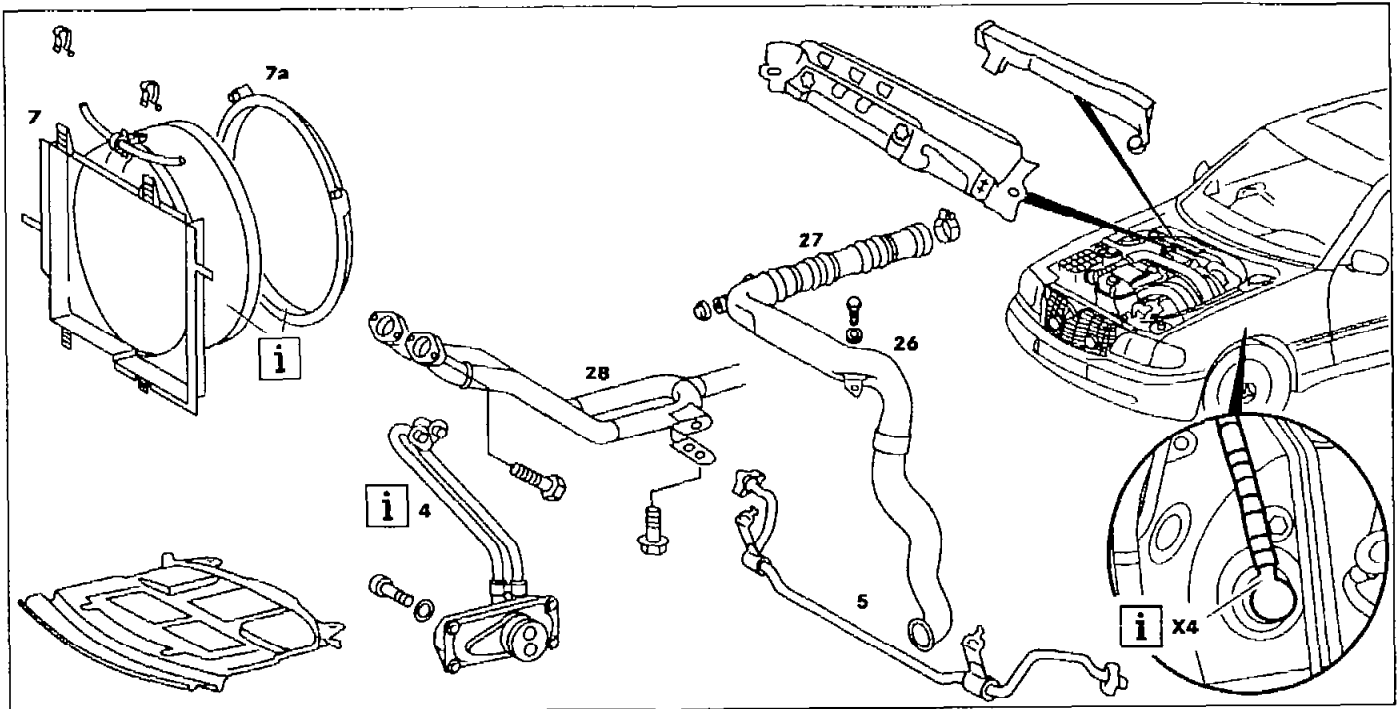

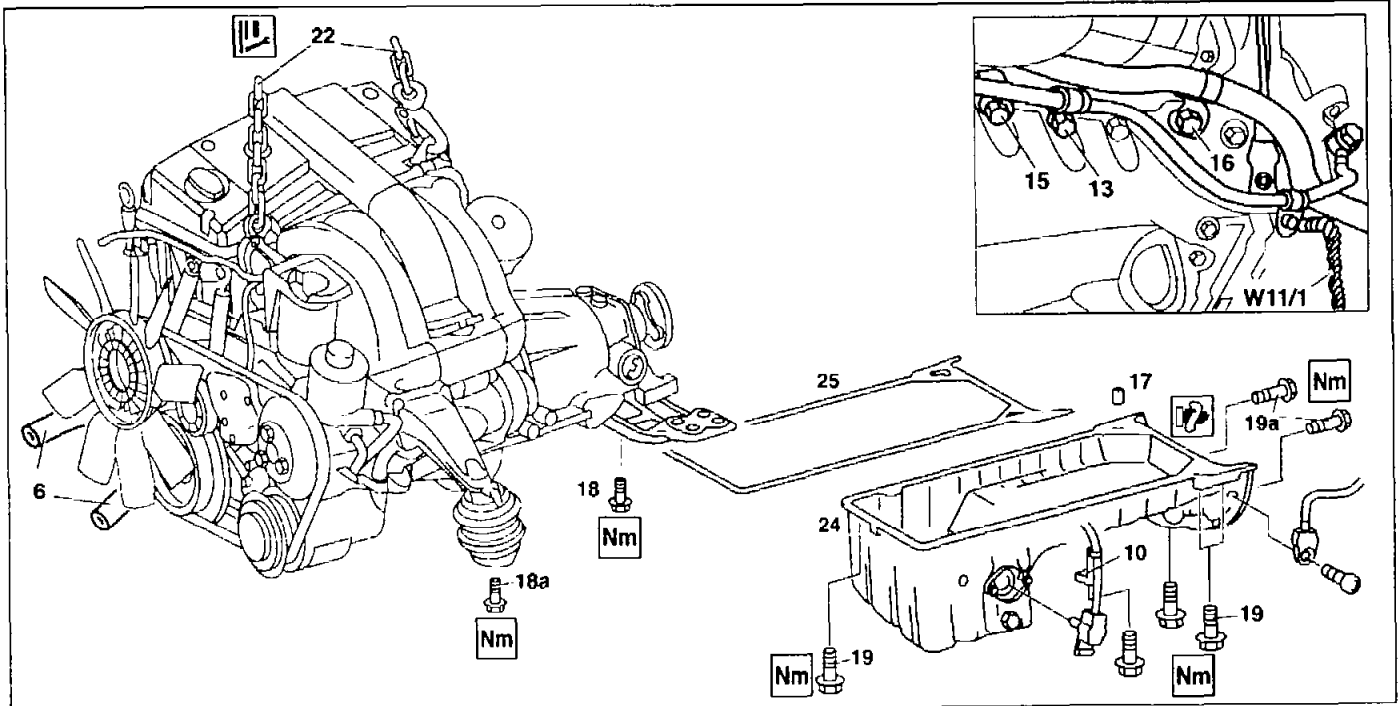









P01.45-0220-09





P01.45-0205-09

	Removing, installing		
1.1	Disconnect charge air hose (27) at pressure regulator housing	Engine 605.960	AR09.41-P-1311H
2.1	Unbolt charge air pipe (26) at radiator	Engine 605.960	AR09.41-P-1311H
3	Detach fan shroud (7) or fan shroud ring (7a) from fixtures and place over fan	Installation on engine 604/605 ↓	



		Adjust fan shroud	AR20.40-P-6800-01HA AR01.45-P-7500HA/4
4	Remove oil-water heat exchanger (4) at the oil sump	Model 124 with oil-water heat exchanger at oil sump Model 202 up to 06.94, with oil-water heat exchanger in oil sump. Drain coolant and engine oil for this step	AR18.30-P-3480HA
5	Remove torsion bar (5) of front suspension	Model 124 Model 202	32-300 AR32.20-P-0300C
6.1	Disconnect ground cable at battery	Model 202	AR54.10-P-0003A
7.1	Unbolt electric cable of starter	 Engine 601,604,605 in model 202 Unbolt cable at terminal block (X4) in left footwell	
8	Remove bolts of engine mounts (18, 18a)	 	BA22.10-P-1001-01A BA22.10-P-1002-01A
9.1	Unbolt exhaust (28) at exhaust manifold and transmission intermediate bearing	Engine 604, 605	AR49.10-P-7000I
10	Remove bolts of oil sump (19, 19a)	 Installation: Pay attention to bracket (10) for electric cable of oil level sensor and attachment of ground strap at transmission bell. If automatic transmission (code 420a, 425a) fitted, pay attention to bracket for ATF lines (13) and transmission wiring harness (15, 16) Pay attention to different lengths and diameters of bolts ↓ Engine 604, 605, 606 bolt diagram of oil pan Align oil sump (24) to rear contact surface at transmission.  If the oil sump is not aligned to the transmission, this can result in noise and vibration problems.  	AR01.45-P-7500-06HA AR01.45-P-7500HA/5 BA01.45-P-1001-01A BA01.45-P-1002-01A
11	Raise engine	  Ensure that the injection line is not damaged when attaching the front engine lifting eye! Do not apply any tensile load to the coolant hoses; detach radiator from its fixtures, if necessary.	AR01.10-P-7500-03HA AR01.45-P-7500HA/6
12	Remove oil sump (24) together with oil sump gasket (25)	 Model 202: If long oil baffle at oil sump, the oil pump has to be removed when oil sump drained ↓	



		<p>Remove oil pump</p> <p>Take oil sump out downward in direction of travel; rotate crankshaft slightly for this step, if necessary.</p> <p>If automatic transmission fitted, press the ATF lines slightly to the side.</p> <p>Clean contact surfaces of the oil sump.</p> <p>Replace gasket of oil sump (25).</p> <p> Installation: Fix gasket of oil sump (25) onto crankcase with grease if necessary.</p> <p>Pay attention to dowel sleeve (17)!</p> <p>If the oil sump is replaced, attach oil level sensor with self-tapping screws.</p> <p></p>	AR18.10-P-6020HA
13	Install in the reverse order		001 589 76 09 00

 Oil sump

Number	Designation		Engine 601, 602 except 602.98, 603 except 603.913/963	Engine 604, 605, 606
BA01.45-P-1001-01A	Bolt of oil sump to crankcase	M6 Nm	10	10
		M8 Nm	25	25
		M10 Nm	40	–
BA01.45-P-1002-01A	Bolt of transmission bell to oil sump	Nm	–	40

 Engine suspension, engine mounts, engine carrier

Number	Designation		Engine 604, 605 in model 202	Engine 605, 606 in model 124
BA22.10-P-1002-01D	Bolt of rear engine mount to rear engine crossmember	Nm	25	25
BA22.10-P-1008-01D	Bolt of engine mount to frame crossmember	Nm	25	40

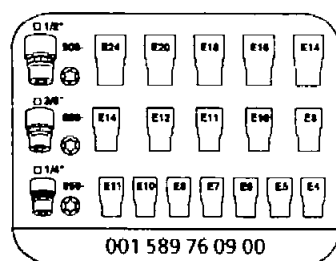

External torx set



Commercially available tools

Number	Designation	Make (e.g.)	Order number
WH58.30-Z-1001-06A	6 mm wrench hexagon on flexible shaft for hose clips with worm drive	Hazet Güldenwerther Bahnhofstraße 25-28 D-42857 Remscheid	426-6
WH58.30-Z-1002-06A	7 mm wrench hexagon on flexible shaft for hose clips with worm drive	Hazet Güldenwerther Bahnhofstraße 25-28 D-42857 Remscheid	426-7
WH58.30-Z-1001-07A	Engine hoist (self-locking)	Bäcker Herderstraße D-42853 Remscheid	3188
WH58.30-Z-1002-07A	Shackle		C1 DIN 82101

AR20.40-P-6800-01HA	Adjusting fan shroud		
---------------------	----------------------	--	--

- 1 Pull off retaining clips (15) upward.
- 2 Adjust fan shroud (7) relative to fan (1).
- 3 Fit on retaining clips (15).

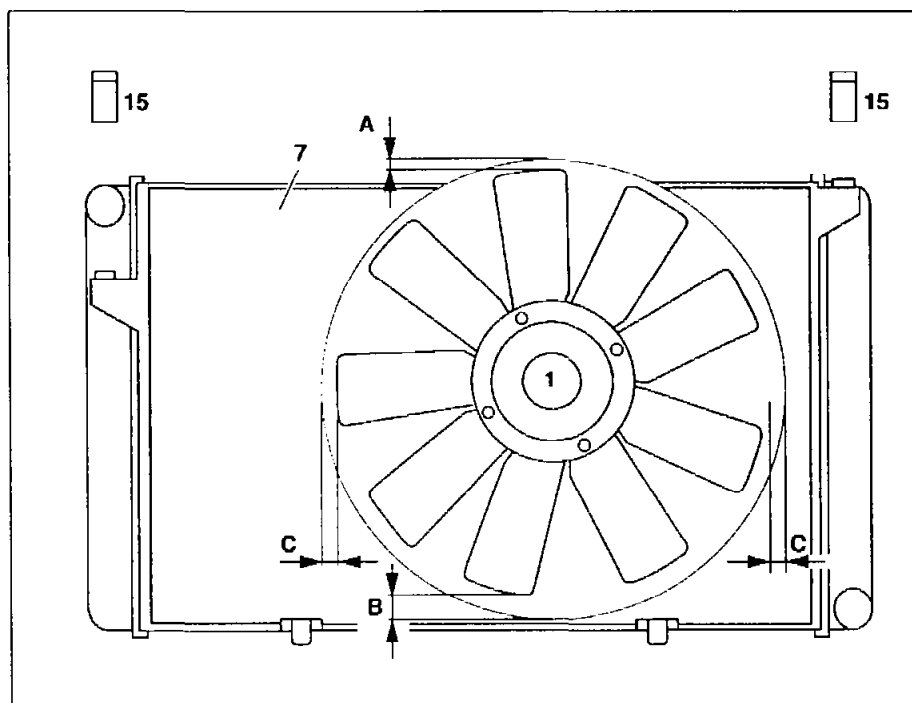

P20.40-0001-06

Engine 111*(with manual transmission)*

- 6 M6×20 bolt + washer
- 7 M6×35 bolt + washer
- 8 M6×85 bolt + washer
- 9 M8×40 bolt + washer
- 10 M10×40 bolt + washer
- 56 Oil sump

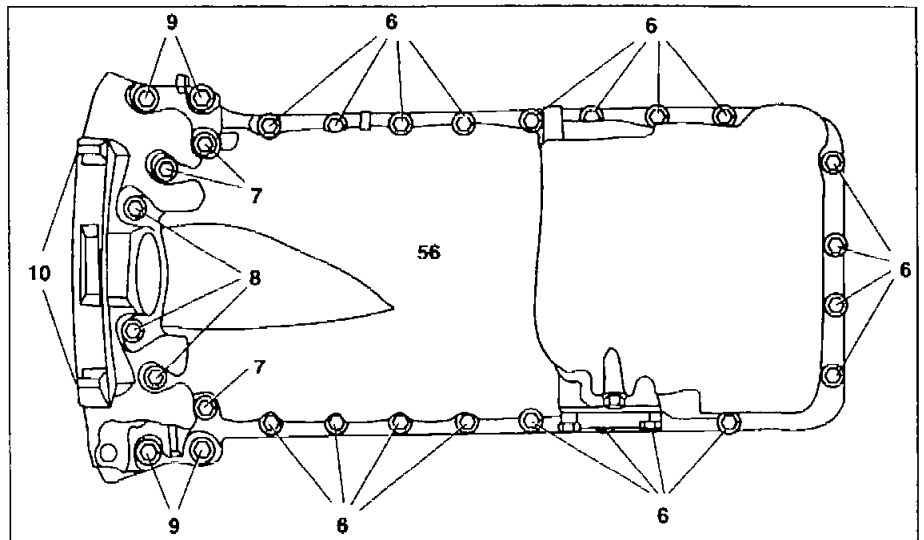

P01.45-0209-05

Engine 604

- 1 M8×40 bolt + washer
- 2 M6×35 bolt + washer
- 3 M6×85 bolt + washer
- 4 M6×20 bolt + washer
- 4a Hexagon socket bolt M6×20 (automatic transmission)
- 4b Hexagon socket bolt M6×75 (automatic transmission)
- 5 M10×40 bolt + washer

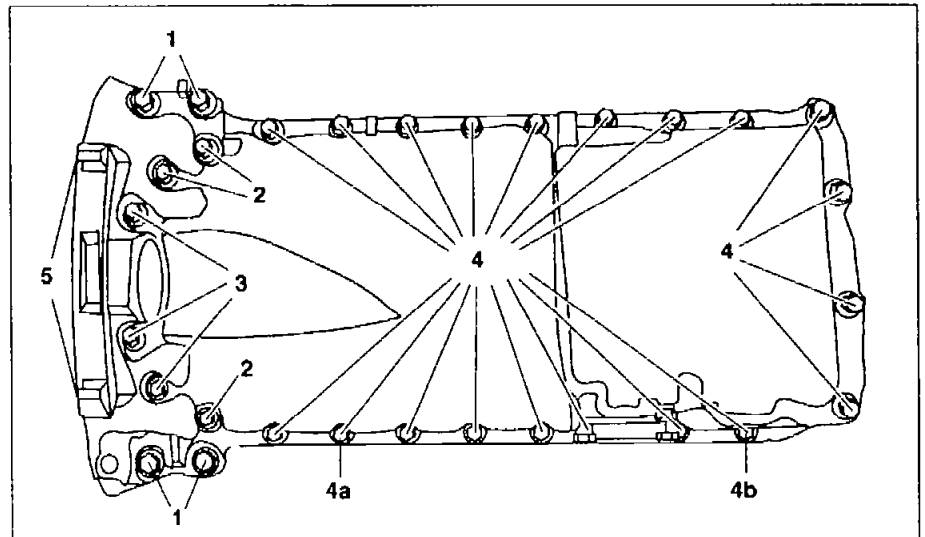

P01.45-0001-05

Engine 602.982/983, 605

- 1 M8×40 bolt + washer
- 2 M6×35 bolt + washer
- 3 M6×85 bolt + washer
- 4 M6×20 bolt + washer
- 4a M6×20 hexagon socket bolt (automatic transmission)
- 4b M6×75 hexagon socket bolt (automatic transmission)
- 4c M6×20 hexagon socket bolt (automatic transmission)
- 5 M10×40 bolt + washer

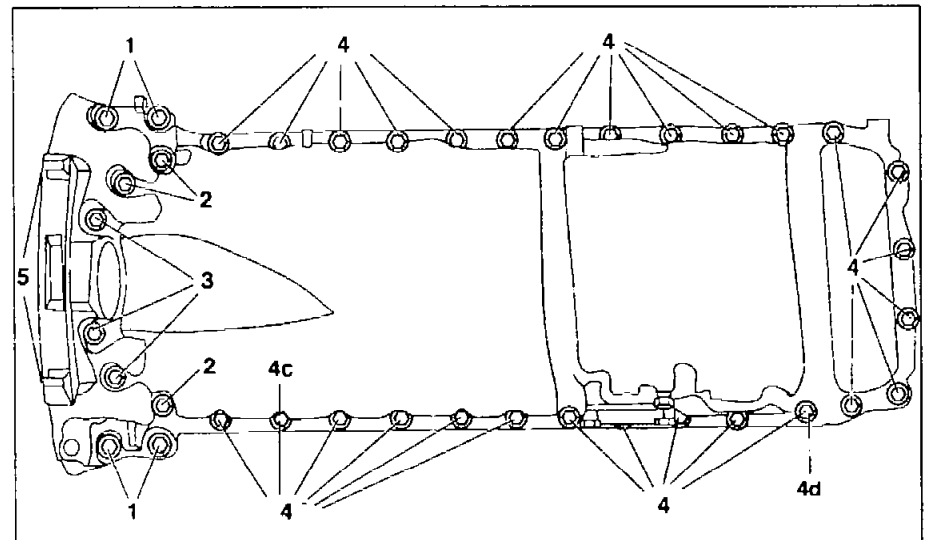

P01.45-0203-05

Engine 606

- 1 M8×40 bolt + washer
- 2 M6×35 bolt + washer
- 3 M6×85 bolt + washer
- 4 M6×20 bolt + washer
- 4c Hexagon socket bolt M6×20
(automatic transmission)
- 4d Hexagon socket bolt M6×75
(automatic transmission)
- 5 M10×40 bolt + washer

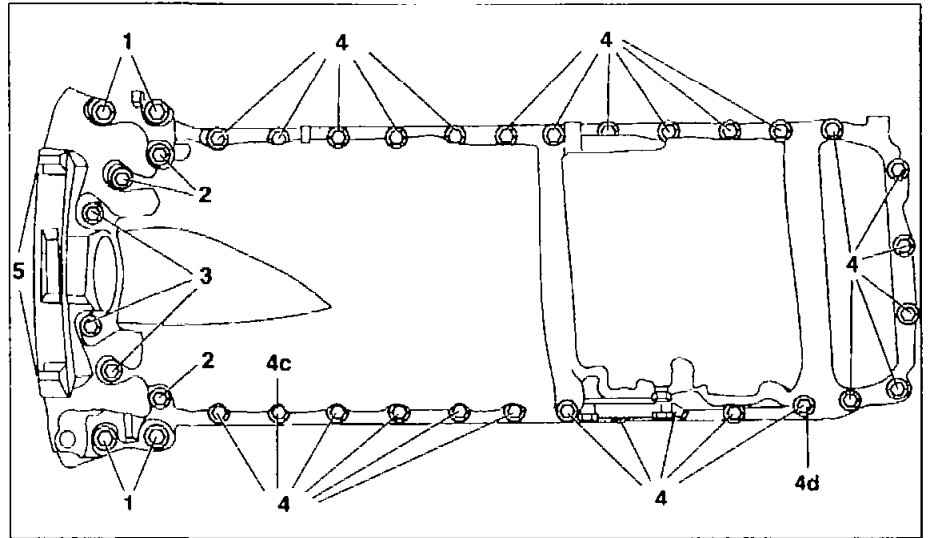

P01.45-0203-05

AR01.10-P-7500-03HA	Raising engine		
---------------------	----------------	--	--

Commercially available tools

Number	Designation	Make (e.g.)	Order number
WH58.30-Z-1001-07A	Engine hoist (self-locking)	Bäcker Herderstraße D-42853 Remscheid	3188
WH58.30-Z-1002-07A	Shackle		C1 DIN 82101

1 Attach engine hoist (50) to the front and rear engine lifting eye.

(i) Ensure that the injection line is not damaged when attaching to the front engine lifting eye! Use shackle (01) as an intermediate piece, if need be.

2 Adjust engine hoist so that engine is raised evenly at the front and rear.

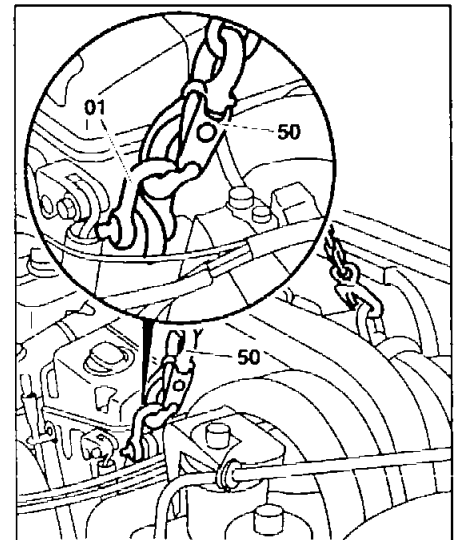

P01.45-0206-02

3.1 Engine 606.961/962: attach chain to exhaust manifold and hook to the 3rd lifting hook of the engine hoist.

(i) Raise engine carefully and pay attention to position; lower once again if necessary and adjust length of chain.

4 Raise engine fully.

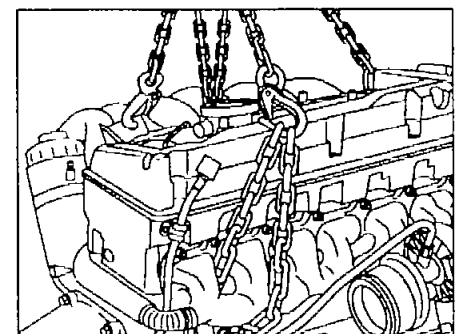

P01.45-0228-01

