

011

AR01.45-P-7500D







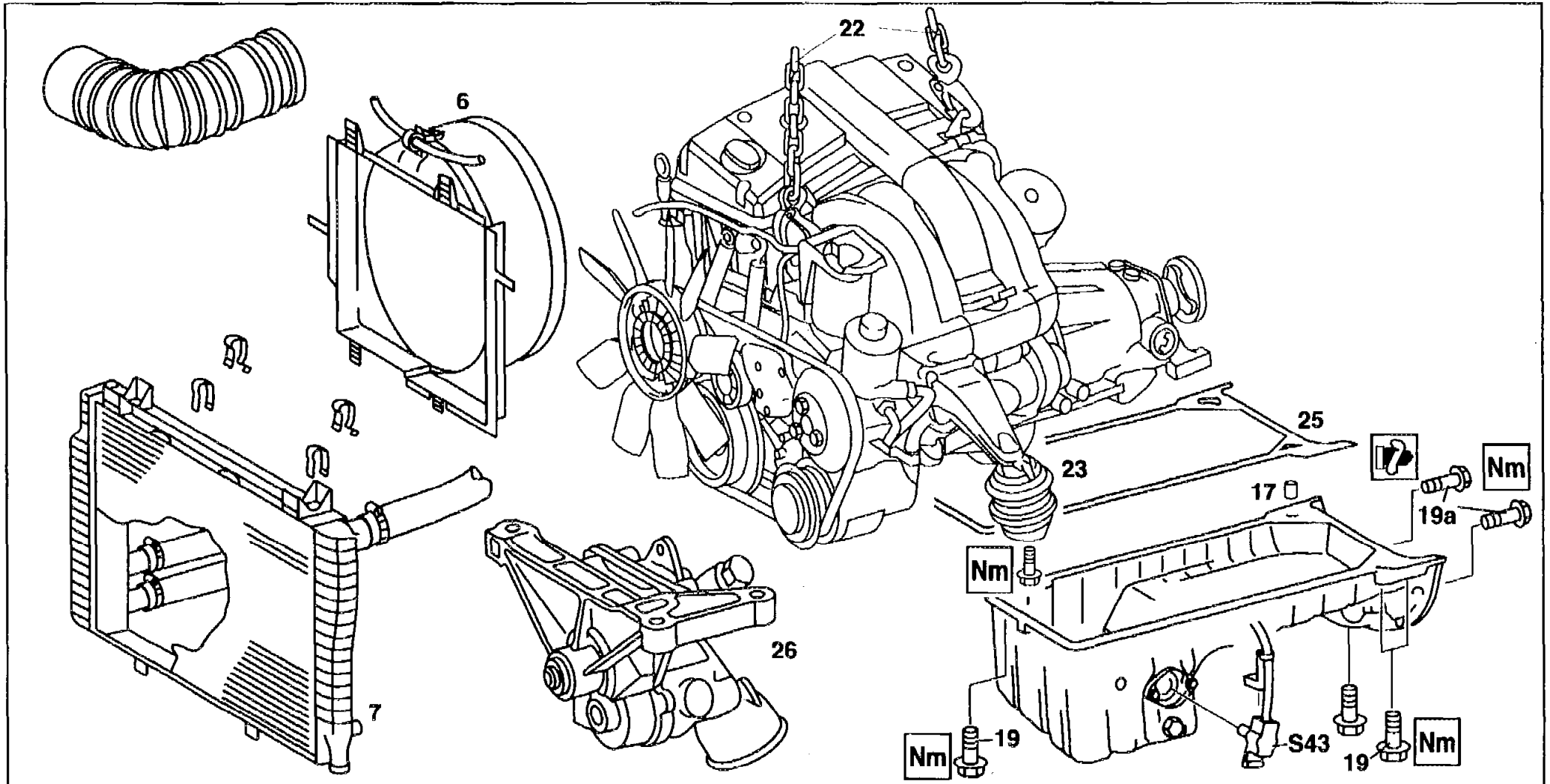

Removing, installing oil sump

17.2.95

ENGINE 604
in MODEL 210





 	Removal, installation		
1	Disconnect ground cable at battery	 Installation: encode radio	
2	Drain engine oil		
3	Detach fan shroud (6) from its fixtures and place over fan		
4	Unbolt pipe of power steering pump at front side member	 To allow engine to be raised	
5	Disconnect electric cable at front left preglow relay	 To allow engine to be raised. See ↓ Disconnect engine wiring harness	AR01.00-P-2410D D2
6	Detach radiator (7) from its fixtures	 To allow engine to be raised	
7	Unbolt front engine mounts (23) at front suspension supporting arm		BA22.10-P-1001-01D
8	Unplug connector of oil level sensor (S43)		
9	Unscrew bolts of oil sump (19, 19a)	  Installation: Pay attention to attachment of ground strap to transmission bell housing. If automatic transmission fitted (code 420a, 425a), pay attention to bracket for ATF pipes. Pay attention to different lengths and diameters of bolts.	001 589 76 09 00



		<p>Align oil sump (24) to rear contact surface at transmission.</p> <p>ⓘ If oil sump (24) is not alined relative to transmission, this can cause noise and vibration problems.</p> <p>Nm</p> <p>Nm</p>	<p>BA01.45-P-1001-01A</p> <p>BA01.45-P-1002-01A</p>
10	Lower oil sump (24)		
11	Remove oil pump (26)		AR18.10-P-6020HA
12	Remove oil sump (24) together with oil sump gasket (25) to the front	<p>ⓘ Installation: clean contact surfaces of oil sump.</p> <p>Replace oil sump gasket (25).</p> <p>Use grease if necessary to fix oil sump gasket (25) to crankcase.</p> <p>Pay attention to dowel sleeve (17).</p> <p>If oil sump is replaced, screw on oil level sensor with self-tapping screws.</p>	
13	Install in the reverse order		

**Nm** Oil sump

Number	Designation			Engine 604, 605, 606
BA01.45-P-1001-01A	Bolt of oil sump to crankcase	M6	Nm	10
		M8	Nm	25
		M10	Nm	–
BA01.45-P-1002-01A	Bolt of transmission bell to oil sump		Nm	40

Nm Engine suspension, engine mounts, engine supporting arm

Number	Designation			Engine 604, 605, 606 in model 210
BA22.10-P-1001-01D	Bolt of front engine mount to front axle carrier		Nm	35

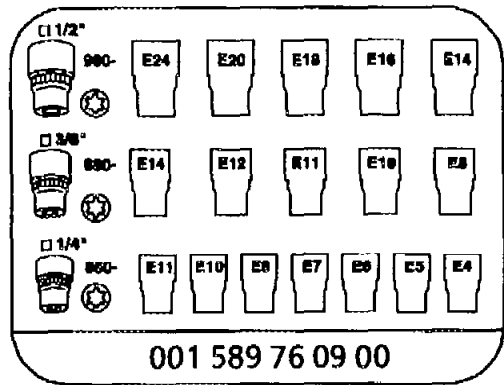

External torx set